

# HYDRO PROFI LINE®

## GREENERY SYSTEMS

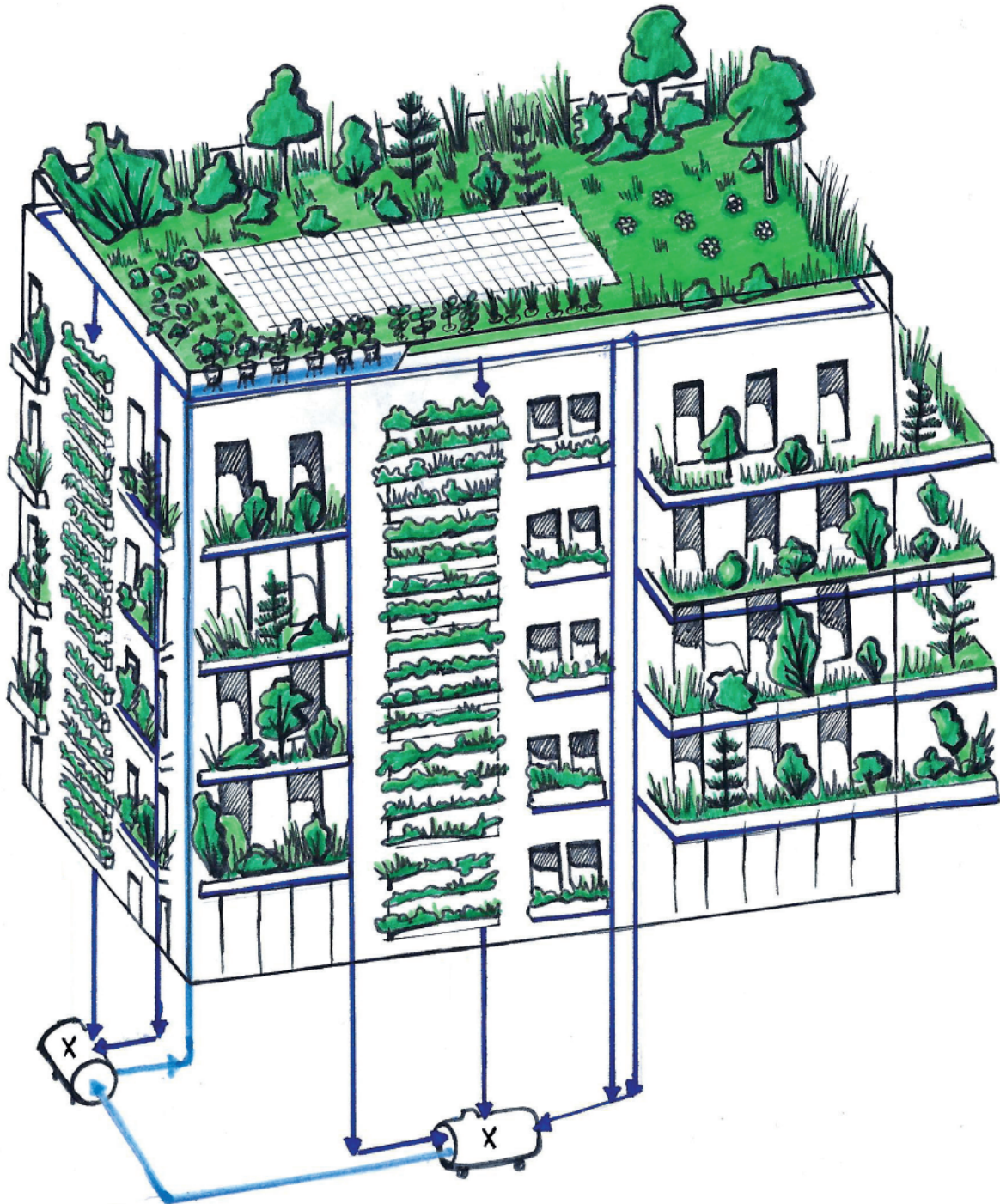

Durable, low-maintenance and cost-effective intensive greening of all horizontal and vertical impervious surfaces. For any location.



## HYDRO PROFI LINE® SYSTEM CATALOGUE I

For architects, municipalities, property developers, landscape gardeners, nurseries, roofers, facade builders, project engineers and everybody else aiming for a healthy urban environment with plants.



UNIQUE – SUSTAINABLE – PERFECT

# Hydro Profi Line® Systems for Greenery



Durable, low-maintenance and flexible intensive greening of all horizontal and vertical impervious surfaces at lowest water consumption and maintenance levels.

MAKING GREEN VISIONS POSSIBLE FOR EVERY LOCATION LIKE NEVER BEFORE.

## HPL® Systems for Areal Greenery



## HPL® Planting Islands



## HPL® Canopies for City Greenery



**HPL® Tall Plants System**

**Also, now available:**

**Hydro Profi Line® Liquid Complete Fertilizer 1000 ml**



**Inorganic fertilizer optimized for Hydro Profi Line® Planter Systems.**

**For any indoor or outdoor plant in soil or hydroculture.**

EAN: 4260369981471

... AND A LOT MORE TO DISCOVER IN THIS CATALOGUE.



UNIQUE – SUSTAINABLE – PERFECT

# Hydro Profi Line® Systems for Greenery



**Enabling any intensive greenery on all impervious surfaces – convenient & cost-effective.**

The Hydro Profi Line® (short: HPL®) Systems for Greenery enable any horizontal or vertical greening at a new level of implementation time, flexibility and sustainability. All Plants flourish splendidly in the game-changing HPL® Planter System. From shrubs, over trees to Mediterranean plants, palm trees, roses – any plant species can be used without the additional deployment of a substrate outside the root ball. With the integration into the unique HPL® System for Building Greenery, manual irrigation and complex irrigation technology are not required anymore. Consequently, the maintenance effort and the risk of malfunction are significantly reduced.

## Hydro Profi Line® for

- ... **Roof Greening,**
  - ... **Facade and Wall Greening,**
  - ... **Terrace Greening,**
  - ... **Areal Greening,**
  - ... **Carport Greening,**
  - ... **Yard Greening,**
  - ... **City Greening,**
  - ... **Indoor Greening**
- and greening of all other impervious surfaces outdoors as well as indoors.**



<b>Hydro Profi Line® Systems for Building Greenery</b>	<b>4-25</b>
<b>Hydro Profi Line® Systems for Areal Greenery</b>	<b>26-31</b>
<b>Hydro Profi Line® Greening Modules for Outdoors and Indoors</b>	<b>32-39</b>
Hydro Profi Line® Cultivation Pot Modules	<b>32-39</b>
Hydro Profi Line® Planting Basket Modules	<b>40-41</b>
Hydro Profi Line® Water Basins	<b>41-42</b>
Hydro Profi Line® Planting baskets	<b>43</b>
Hydro Profi Line® Footway and Supply Modules	<b>44</b>
Hydro Profi Line® Grid for Roof and Areal Greenery	<b>45-49</b>
Hydro Profi Line® Wall- and Facade Greening Modules	<b>50-52</b>
<b>Hydro Profi Line® Canopies for City Greenery</b>	<b>53-61</b>
<b>Hydro Profi Line® Tall Plants System</b>	<b>62-67</b>
<b>Hydro Profi Line® Planters</b>	<b>68-73</b>
<b>Hydro Profi Line® Room Divider / Plant Pictures</b>	<b>74-75</b>
<b>Hydro Profi Line® Multifunctional Planters and Constructions</b>	<b>76-80</b>
<b>Hydro Profi Line® Glossary / GKR Germany I.E.P.T.-Center (Information, Exhibition, Planning and Training Center)</b>	<b>81-82</b>

### Imprint:

G.K.R.-Hydrokulturen GmbH (G.K.R.-Germany)  
Himmelschlüsselstraße 60  
GER-80995 Munich  
Managing Director: Wolfgang M. Plattner  
Telephone +49 (89) 159 14 80  
Fax + 49 (89) 15 17 78

Copyright / Editing and Content: G.K.R.-Germany  
Photos / Graphics: G.K.R.-Germany, Fotolia  
Hydro Profi Line® Systems:  
Invention / Product Development / Patent Rights Wolfgang M. Plattner  
Production / Distribution / Selling: G.K.R.-Germany



## First of its Kind: Hydro Profi Line® Systems for Building Greenery – Outdoors



We are proud to present the first of its kind **HPL® Systems for Building Greenery**. Never before, it has been so easy to accomplish a well-functioning intensive and extensive greening of buildings. To implement the greening desires for abundant roof greening, balcony greening, terrace greening and yard greening the only requirement is a water basin with 13 cm filling level.

- At first, the water basins are installed onto the areas purposed for greening
  - Next, the **HPL® Module Systems** are positioned in the basins and bolted together
  - Finally, the desired plants inside **HPL® Special Cultivation Pots**, or in case of areal greening the **HPL® Planting Baskets** are put into the **HPL® Module Systems**
- That's all, your greening project is completed

Even after years, areas greened this way can easily be dismantled the same way. As we solely use high-quality materials like stainless steel for our **HPL® Module Systems** and produce and project subject to the Cradle to Cradle® principles in the long term we take back used **HPL® Module Systems** by arrangement.

When greening with **HPL® Systems for Building Greenery** absolutely no planting substrate inside and around the planter modules is used which significantly reduces the static load as well as the planting work for the desired greening area.

The plants are supplied with water primarily by rainwater utilization. In southern, arid countries with low amounts of rainfall the plants are additionally irrigated through a freshwater connection. When using **HPL® Module Systems** the water consumption for greening is sustainably reduced by up to 80% compared to any other known planter system.

In addition to the horizontal greening possibilities, vertical **HPL® Wall and Facade Greening Modules** can be integrated into the **HPL® System for Building Greenery** without any problems.

Of course, the **HPL® Systems for Building Greenery** come along with all other benefits of the patented **HPL® Planter Systems**.



# Hydro Profi Line® Systems for Building Greenery: Outdoors

## Options for Installation and Water Supply

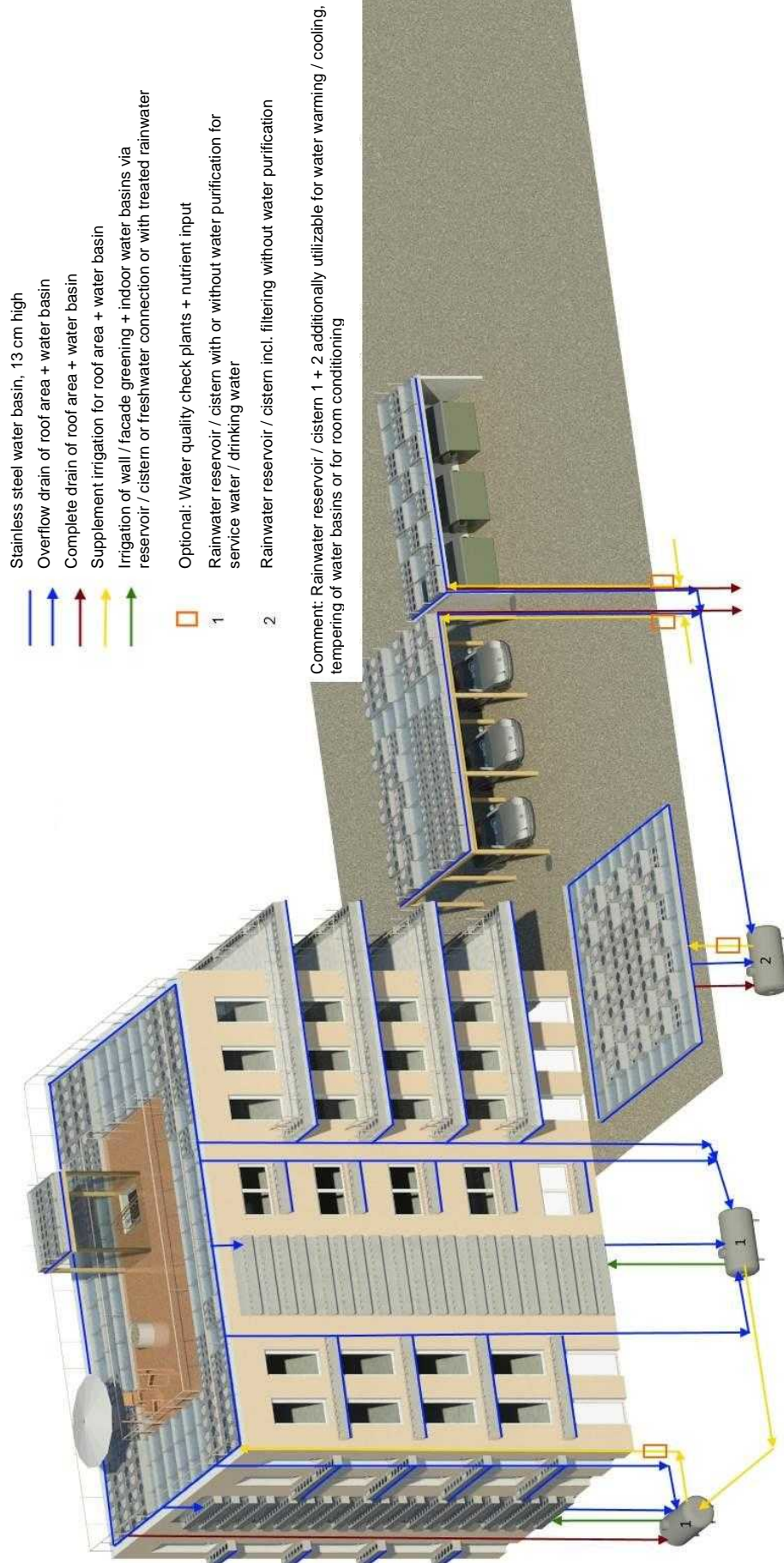



# Hydro Profi Line® Systems for Building Greenery: Indoors



## Options for Installation and Water Supply

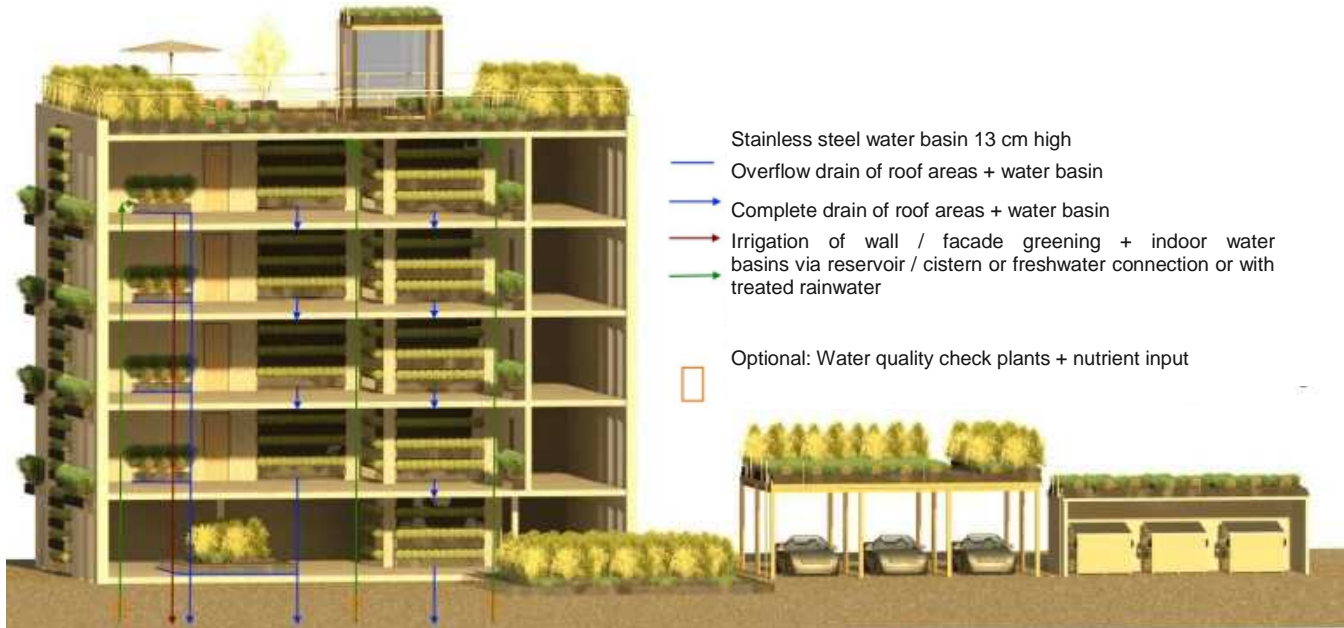

The **HPL® System for Building Greenery Indoors** can be installed stand-alone or connected to the **HPL® System for Building Greenery Outdoors**. Water is supplied to the single greening elements via rainwater utilization from the reservoir / cistern, or alternatively with water from a freshwater connection.

Like outdoors, indoor areal greening can be installed equally simple and affordable in a modular way. Here, too, the only requirement is a water basin with a filling level of 13 cm. The basins are simply installed on the floor or at ground level embedded in the floor. Every indoor plant in any size can be used adequate to the site and the light conditions. The **HPL® Module Systems, Mobile Systems** and **Stationary Systems** only need to be positioned in the basin and the desired plants put into the modules. The water basins can be completely or partially greened, while with partial greening fountains can be integrated without considerable extra effort. If desired, additional spotlights for illumination of the plants or other technical elements as required can be integrated in any **HPL® Module System**. Even large plants can be moved within the basin at any time when using **HPL® Mobile Systems**.

Of course, our **HPL® Wall Greening Systems** can be integrated in any size into the **HPL® System for Building Greening Indoors** and supplied with water via the rainwater utilization concept.

Every indoor areal and wall greening element can be installed independently from the comprehensive **HPL® System for Building Greenery**. In this case the elements are supplied via a stand-alone freshwater connection or irrigated manually. Whether stand-alone or as part of the integrated system the water consumption for greening with **HPL® Planter Systems** is reduced by up to 80% and subsequently the irrigation work.



*Commonly unfamiliar is the fact that indoor air quality is by 10 times worse than outdoor air quality in terms of fine dust and other air containment in many cases. Our areal and wall greening solutions efficiently absorb fine dust and reduce the existing air pollutants. Moreover, the greenery produces oxygen, regulates humidity and cater for healthy air to breathe.*



## Hydro Profi Line® Systems for Building Greenery: Intensive & Extensive Roof Greening



From now on it is possible to green all flat roofs as well, smooth and without long-term risks. Equally, existing flat roofs can be upgraded quickly and easily and abundantly planted with the **HPL® Systems for Greenery**. You are looking for a partial or complete greening of the roof? No problem at all. Usable areas in any size can be integrated into the roof greening system. Likewise, it is possible to offer single planter modules to the residents and other users for self-reliant cultivation with blossoming plants, herbs or vegetables. Every outdoor plant like shrubs, conifers or trees in any size fit into the **HPL® System for Greenery**. Seamless incorporation of areal greening with grasses, perennial plants or groundcover plants is as well possible. Planting substrate is not at all required for planting with **HPL® Planter Modules**. The plants are simply put into the installed planter modules. With the **HPL® Quick Change System** every single plant can be exchanged selectively without planting work whenever you want, even after years. There is no cleaner, easier or faster way for greening. Moreover, water is supplied automatically via the available rainwater with a sustainably reduced water consumption of up to 80% compared to conventional greenings. Additionally, the 13 cm water level in the basins provide an ideal and natural roof insulation for every building.



*“Let us now green our roofs and bring back healthy and sustainable urban environments with clean air to our cities.”*

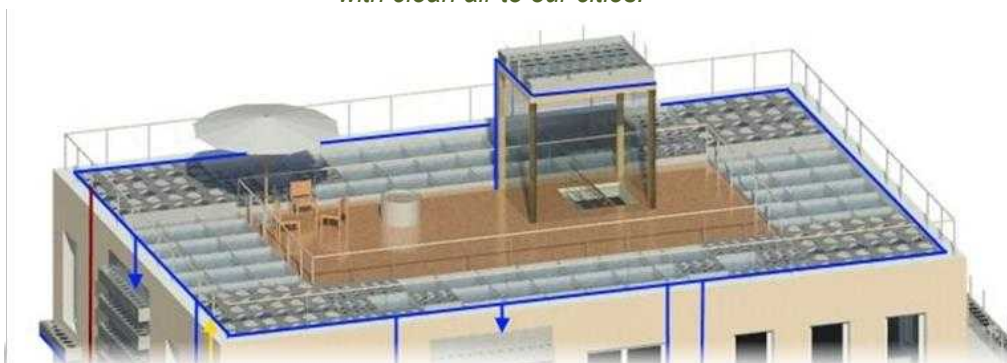



# Hydro Profi Line® Systems for Building Greenery: Rainwater Basins & Planter Modules



## 1) Roof area with zero pitch (level) – usually only with new buildings

Option 1: Application of horizontal water basin made of stainless steel on existing roof sealing

Option 2: Utilization of roof sealing directly for formation of water basin without additional stainless steel basin

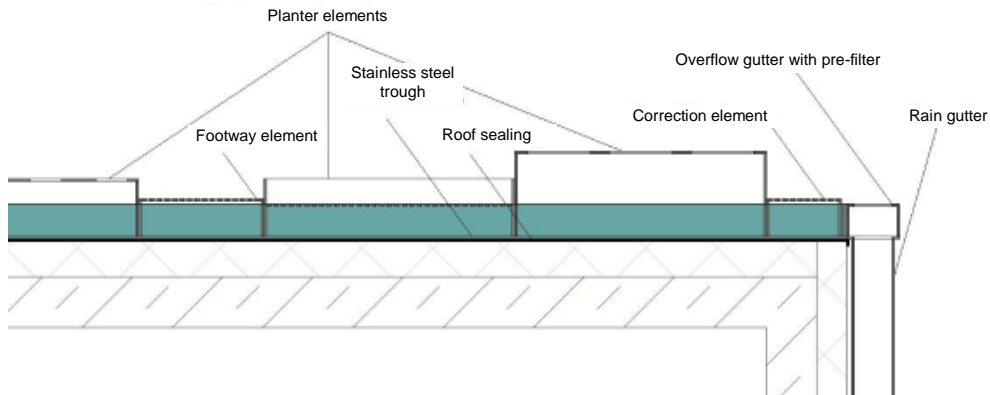

## 2) Roof area with roof pitch

a) Compensation fill for level regulation with horizontal floor panel;  
water basins made of stainless steel on floor panel:

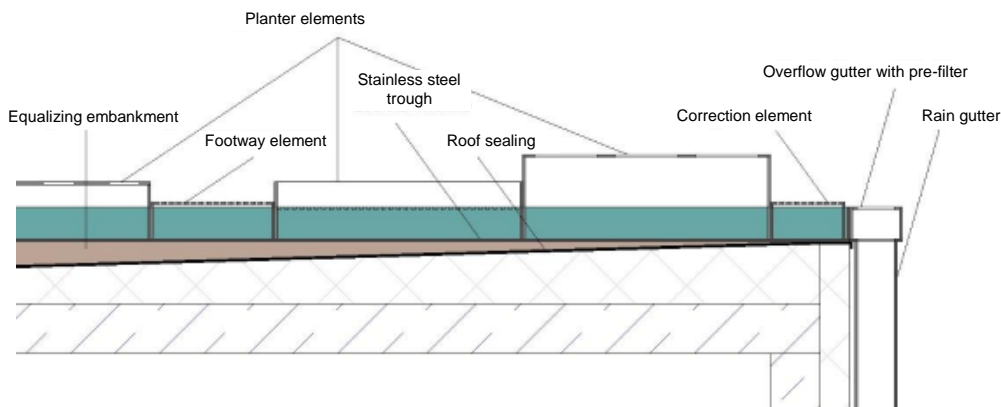

b) Compensation fill for level regulation with horizontal floor panel;  
Water basin with edge made of stainless steel and with sealing made of roof sealing material incl. root protection sheet on floor panel:

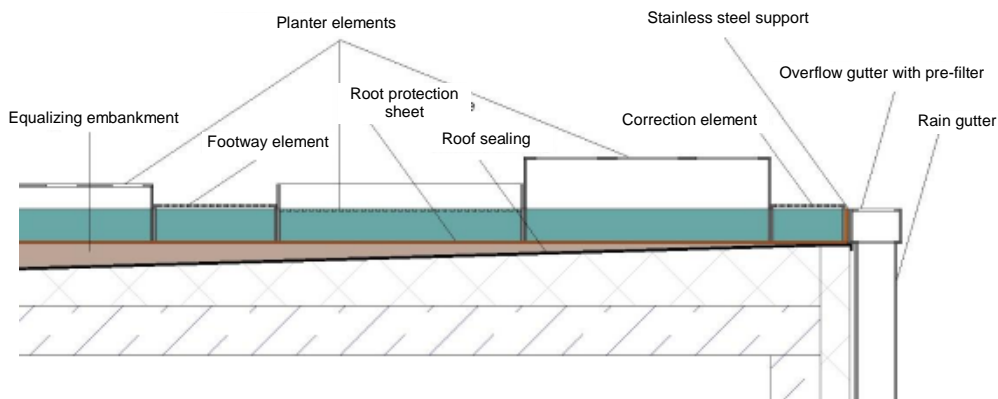





## Hydro Profi Line® Systems for Building Greenery: Rainwater Basins & Planter Modules



c) Level control of the horizontal planting area through adjustment of the planter modules in line with the roof inclination;

Option 1: Application of water basin made of stainless steel parallel to existing roof sealing

Option 2: Utilization of roof sealing directly for water basin formation w/o additional stainless steel basin:

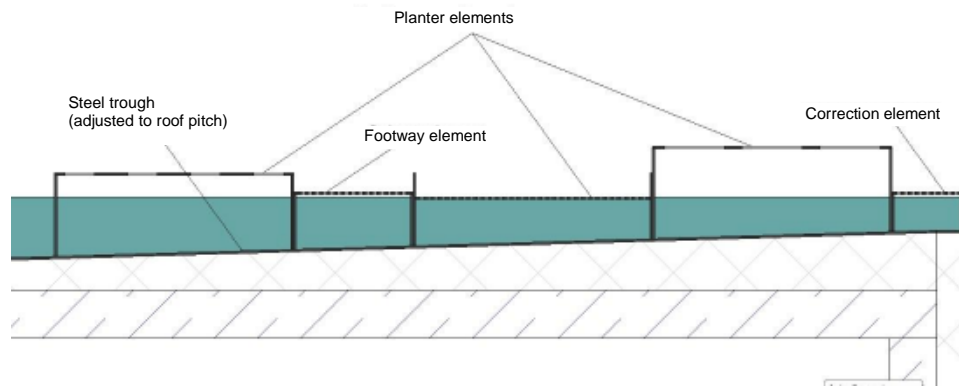

Besides the presented structural options for construction of the water basin on roof areas, we are happy to develop solutions together with you individually fitting your building.

**HPL® Modul Systems** allow for a wide range of possible applications: Generally, the **HPL® Planter Modules** come with a basis of 100 cm x 100 cm or 100 cm x 50 cm. The height of the modules depends on the intended plant species and size. Generally, **HPL® Footway Modules** come with a basis of 100 cm x 50 cm and 15 cm in height. Correction Modules are custom-made to fit to the respective basin size. Of course, we can produce the **HPL® Modules** in any desired size and shape matching your individual greening scheme. All **HPL® Modules** are made of high-quality durable stainless steel. The module elements can as well be bolted together prior to the planting.

**It has never been so easy to intensively / extensively green roof areas, partially or completely:**

1. Install water basin on the roof area with at least 13 cm water level
2. Position **HPL® Modul System** according to the desired plants or greening concept in the water basin
3. Put **HPL® Special Cultivation Pots** or **HPL® Planting Baskets** in **HPL® Modules**

→ That's all for an opulent, durable, low-maintenance and water-saving roof greening

From now on, your greenery benefits from all advantages of the patented **HPL® Planter Systems**. And you benefit from a low-maintenance, opulent and healthy roof greening, everyone will envy you.



*Now we can sustainably green our buildings and impervious surfaces to secure a healthy open urban space for humans and animals. Imagine butterflies, singing birds and plenty of useful insects returning to our cities.*



# Hydro Profi Line® Systems for Building Greenery: Irrigation and Drainage System

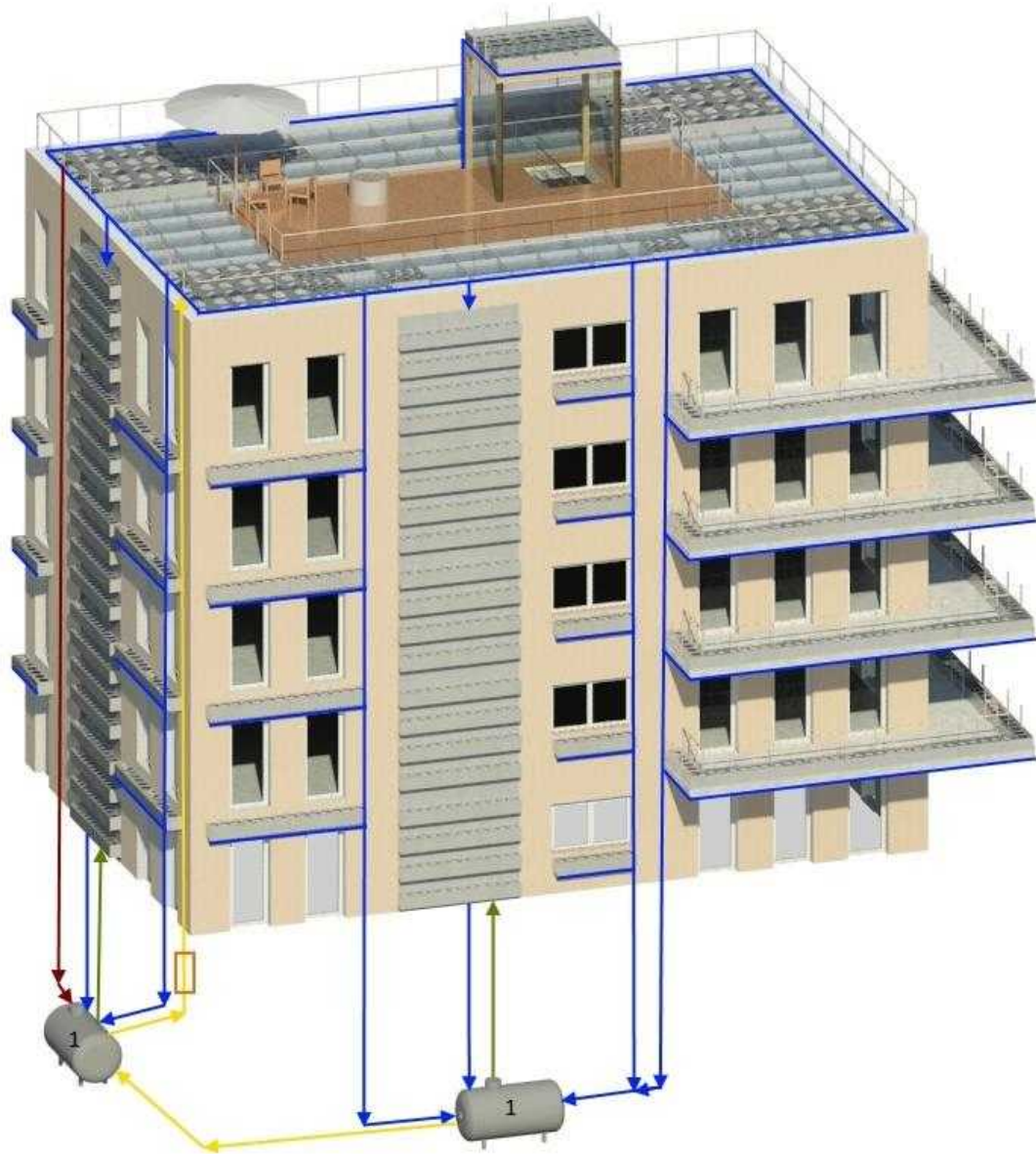

- Stainless steel water basin 13 cm high
- ➔ Overflow drain of roof areas + water basin
- ➔ Complete drain of roof areas + water basin
- ➔ Supplement irrigation of roof areas + water basin
- ➔ Irrigation of wall / facade greening + indoor water basins via cistern or freshwater connection or with treated rainwater



Optional: Water quality check plants + nutrient input

1

Water reservoir / cistern with or without treatment for service water quality / drinking water quality

Comment: Rainwater reservoir / cistern 1 additionally utilizable for water warming / cooling, tempering of water basins or for room conditioning



## Hydro Profi Line® Systems for Building Greenery: Irrigation and Drainage System



Overflow- and drainage system for water basins with utilization of roof sealing:

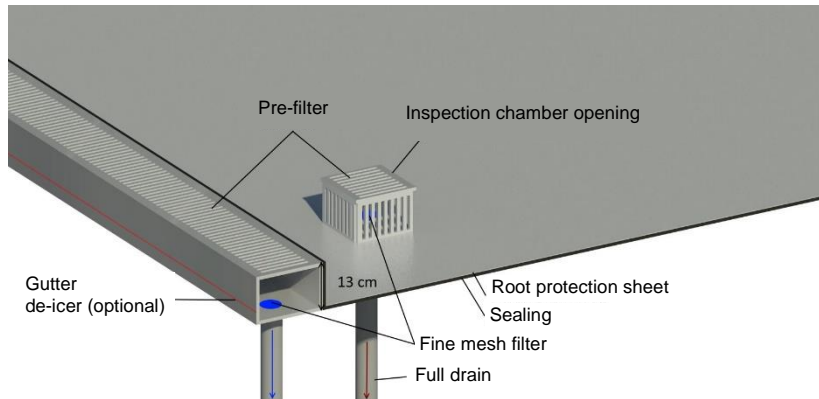

Overflow- and drainage system for separate water basin on roof sealing:

Water basin overflow system:

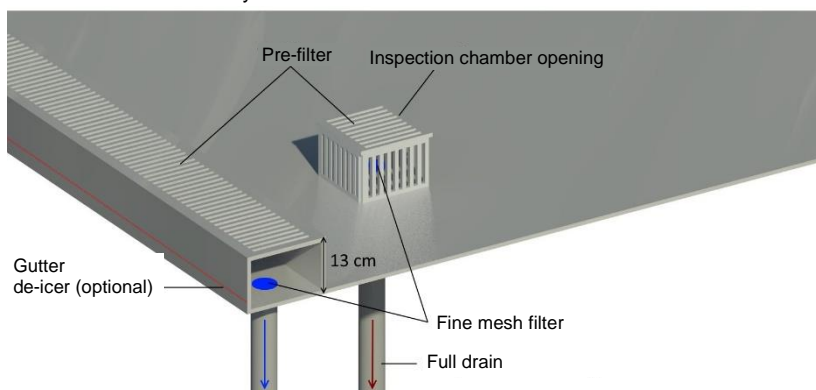

Irrigation of the systems for building greenery is generally carried out with a continuous water circulation by use of the roof area rainwater. After passing a pre-filter excess rainwater drains into the gutter. Subsequently the water flows through a fine filter into the stack pipe. The water from the stack pipe is then used for irrigation of the lower terrace, balcony or facade greening. With terrace and balcony greening the water runs likewise into water basins according to the roof area drainage system (for details see following page). For supply of the facade greening elements the water flows into the top elements from the stack pipe. Through the cascading overflow outlet system, the water is fed into the lower facade greening elements. Finally, the water can be fed into ground-floor water basins for areal greening in yards or parking areas. According to the desired greening undertaking the water of the last greening element is discharged into a water reservoir / cistern for storage or treatment. Refill of single water basins with water from the reservoir / cistern is done with pumps. In case the reservoir / cistern water level is too low additional water can be supplied via a freshwater connection. If wanted, water circulation, water level and water temperature can be surveilled, interpreted and controlled with measuring elements. When using the water reservoir / cistern solution municipal drainage fees can be saved accounting for the greened area. Furthermore, in case of heavy rainfalls **HPL® Systems for Building Greenery** relieve the highly overstrained canalization systems in large cities.

Of course, every **HPL® System for Building Greenery** can be installed solitarily and without integration into the water circulation. Irrigation is then done through a freshwater connection and excessive rainwater from the basins is discharged into the canalization without further exploitation.



## Hydro Profi Line® Systems for Building Greenery: Balcony and Terrace Greening



Intensive balcony and terrace greenings are as easy to realize with **HPL® Modul System** as our roof area greening. Here, too, we simply install a water basin with at least 13 cm water level and integrated overflow outlet. Irrigation for this greening is provided through rainwater utilization via the greened roof area and through connection to the roof rainwater pipes. Alternatively, the plants can be supplied with a freshwater connection. Excessive rainwater can be collected in a rain barrel or cistern and utilized for irrigation at a later point in time.

After installing the water basins, the **HPL® Modul Systems** are positioned in the basins and the balconies and terraces are ready for greening. No matter if seasonal blossoming plant, all year green plants, shrubs, roses, herbs, conifers or trees: all plants can be used for greening of balconies and terraces. The size of the water basins and the **HPL® Modul Systems** depend on the desired plants. After developing of a greenery concept and positioning of the **HPL® Modul Systems** in the water basins accordingly, the plants together with the soil around the root ball are set into the **HPL® Special Cultivation Pots** and finally put into the module systems. With minimal effort, the balcony and terrace greening is finished.

In case single plants fade or simply are not pretty anymore, the plants in their **HPL® Special Cultivation Pot** can easily be taken off the module. Subsequently, the over and over reusable **HPL® Special Cultivation Pots** can be equipped with new plants and positioned back into the module system. That's it for the plant replacement without tedious planting work. We call this efficient process **HPL® Quick Change System**.



*Let's now green our balconies and terraces for a better climate and let's enjoy the wonderful power and diversity of our amazing flora.*



# Hydro Profi Line® Systems for Building Greenery: Balcony and Terrace Greening

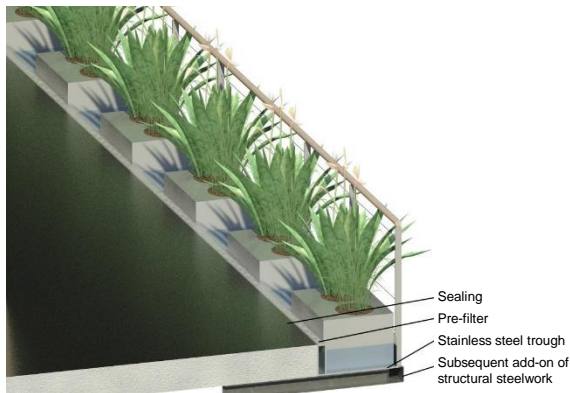

Fig. 1: Balcony parapet  
Add on of water basin

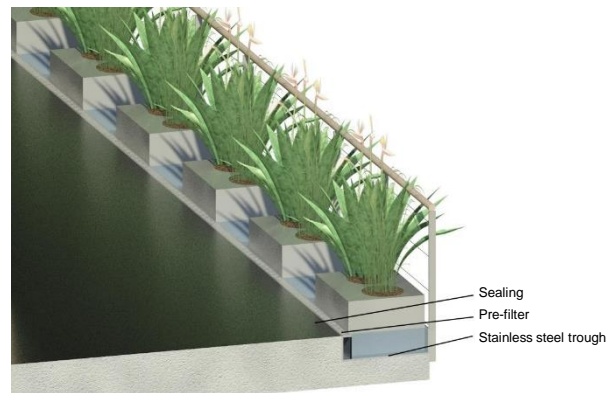

Fig. 2: Balcony parapet new building  
Installation of water basin



Fig. 3: Balcony new building / tiles on concrete – floor  
modules Installation of water basin



Fig. 4: Balcony new building / floorboards – floor modules  
Installation of water basin

Regardless of whether you mount the **HPL® System for Building Greenery** upon the balcony or terrace parapet for smaller plants or on the ground for larger plants, you simply need a water basin with at least 13 cm filling level and the **HPL® Planter Modules**, which are set up in the basin. The width of the water basins and planter modules depends on the desired plants. The water basins are connected to the **HPL® Irrigation and Drainage System** for automatic supply with water and nutrients. Every balcony and terrace can be equipped respectively upgraded with the **HPL® System for Building Greenery**. When greening parapets (see Fig. 1 and 2) usually smaller plants are used, e.g. seasonally blossoming plants, smaller conifers, sedums, herbs, tomatoes or lavenders. When greening ground modules (see Fig. 3 and 4) larger plants like broad-leafed trees, hedge plants, bamboos, frost-resistant conifers or shrubs are possible – depending on the available space and desired plant size. With the help of the **HPL® Quick Change System** even Mediterranean plants like oleander, palms and hibiscus can be put into the **HPL® System for Building Greenery** during the summer months and removed for overwintering. With **HPL® Systems for Building Greenery** all plants grow splendidly and every greening desire becomes reality.

Of course, all **HPL® Balcony and Terrace Modules** can be installed without connection to the **HPL® System for Building Greenery**. In this case the water supply comes from rainwater and if not sufficient with supplemented freshwater. Consequently, the water level needs to be visually inspected on a regular basis.



## Hydro Profi Line® Systems for Building Greenery: Wall and Facade Greening

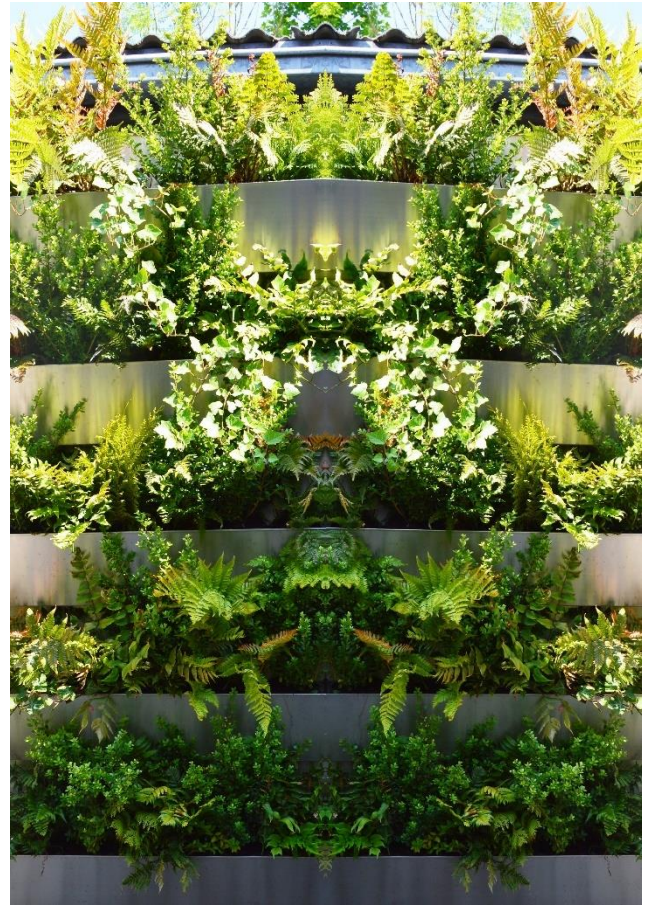

From now on, with the **HPL® Systems for Building Greenery** intensive wall and facade greenings are easy to realize in any dimension. You simply apply our **HPL® Wall and Facade Greening Modules**, made of high-quality durable stainless steel and generally 100 cm in width. Available in three different depths the modules can hold **HPL® Special Cultivation Pots** with diameters 13,5 cm / 15,0 cm / 21,5 cm. Depending on the desired greening, the wall and facade greening modules can be combined with each other. All outdoor plants can be used for the greening. You can choose between evergreen frost-resistant plants like conifers, shrubs, ferns and trailing plants or a combination of frost-resistant plants together with seasonal blossoming and herbs, which can be exchanged after fading or consumption – quick and easy. All plants grow splendidly in the **HPL® Wall and Facade Greening Modules** and do not require any irrigation or fertilizing work when integrated into the **HPL® System for Building Greenery**. The highest wall or facade greening elements are either connected to the roof drainage or supplied with water pumped up from a rainwater cistern (1). Through an overflow outlet the water runs cascading from the top planter module one after the other until the lowest planter module. Excess water is returned to the rainwater cistern (1), or – if not available – discharged into the canalization. From the basin (1) respectively the cistern (1) the water is pumped up to the roof area or the highest wall or facade greening module. In case of utilizing the water circulation the water is purified automatically through the roots growing in the **HPL® Planter Systems** and existing pollutants are partially reduced.

For the very first time **HPL® Facade and Wall Greening Systems** allow for beautiful and low-maintenance intensive building greenery without long-term risks. Additionally, the water consumption with greening in **HPL® Planter Systems** is permanently reduced by up to 80% compared to other greening solutions. Even cities in arid regions are enabled to be widely greened to create healthy urban open spaces and to contribute in actions against climate change.



## Hydro Profi Line® Systems for Building Greenery: Wall and Facade Greening

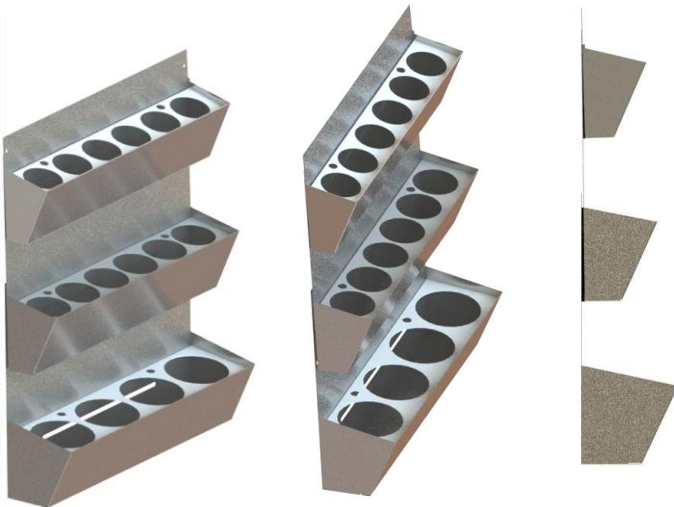

Fig. 1: Wall / Facade module with three different depths installed one upon the other



Fig. 2: Single Wall / Facade Module; assembly stop left

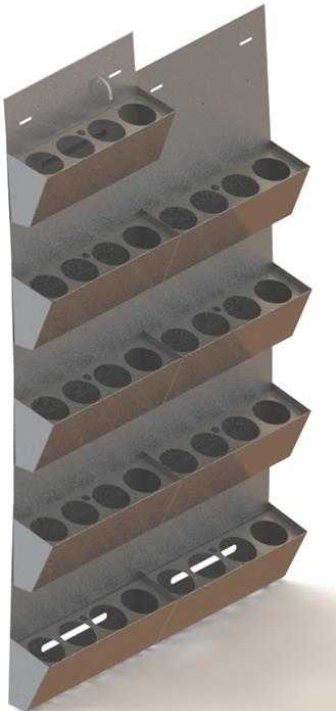

Fig. 3: Wall / Facade Module installation



Fig. 4: Installation pre-drillings / assembly stop

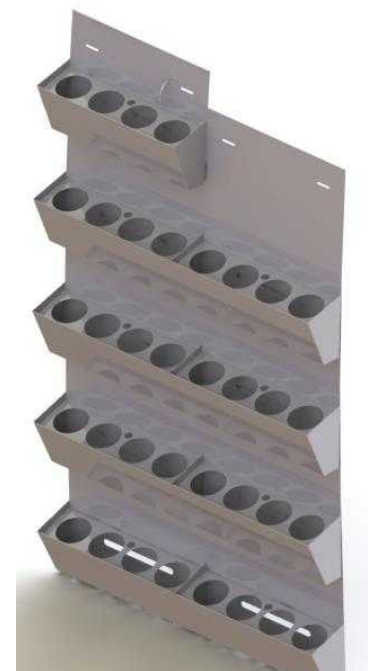
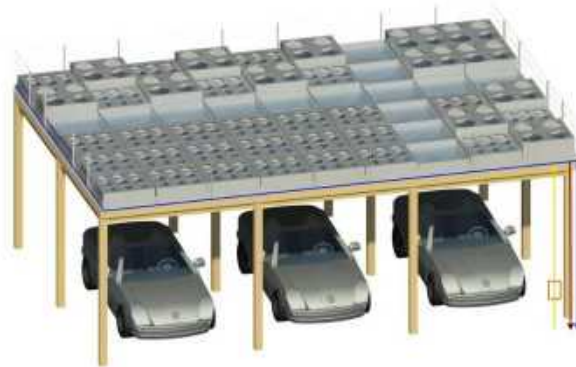

Fig. 5: Module made of high-quality stainless steel

**HPL® Wall and Facade Modules** can be mounted to any carrying wall or facade. After selection of the desired greening suitable to the local conditions (e.g. temperature, sun light exposition) the **HPL® Wall and Facade Modules** are mounted along the planned widths from bottom row to top row. Special attention should be paid to meeting the spirit level horizontally. Starting with the lowest row the modules are attached overlapping and with the desired space in between. To ease installation work, each module comes along with an assembly stop as a mounting aid on the left overlapping edge. Additional thermal insulation can be fitted between the modules and the wall / facade optionally. The installation of **HPL® Wall and Facade Modules** should only be conducted by qualified facade builders respectively construction firms under consideration of bearing strength as well as mounting capabilities of the wall or facade. Bearing loads need to be calculated accordingly.



# Hydro Profi Line® Systems for Building Greenery: Carport, Store & Bin Store Roof Greening



- Stainless steel water basin 13 cm high
- Overflow drain of roof areas
- Complete drain of roof areas
- Supplement irrigation roof areas
- Optional: Water quality check plants + nutrient input

Fig. 1: Carport-roof greening – water basin with installed **HPL® Planter Modules**

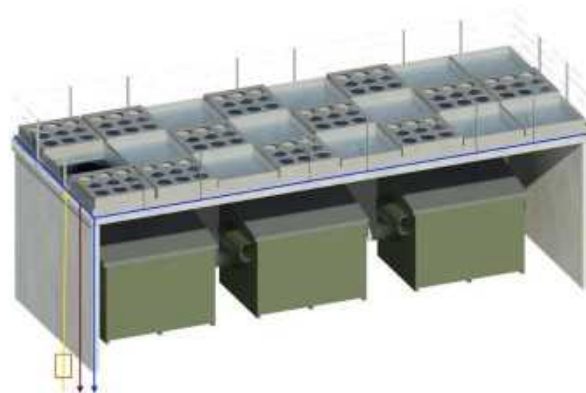

- Stainless steel water basin 13 cm high
- Overflow drain of roof areas
- Complete drain of roof areas
- Supplement irrigation roof areas
- Optional: Water quality check plants + nutrient input

Fig. 2: Store and bin store roof greening – water basin with installed **HPL® Planter Modules**

All roofed floor spaces like carports, stores and bin stores (Fig. 1 and 2) as well as yards and other plane areas (Fig. 3 next page) now can be intensively and extensively greened. The greening can either be integrated into the **HPL® System for Building Greenery** of the main building or equipped with an own **HPL® Irrigation System** together with a separate rainwater reservoir or cistern (1 – Fig. 3 next page).

Of course, this type of greening can as well be installed without connection to the **HPL® Building Irrigation System**. In this case the greening is supplied with rainwater and if not sufficient additionally with freshwater. Water levels are inspected visually or automated via sensors. Water in addition to the rainwater is supplied manually or through a separate irrigation system. In case of storm rainfall superfluous rainwater is directly discharged into the canalization.





## Hydro Profi Line® Systems for Building Greenery: Yard and Areal Greening

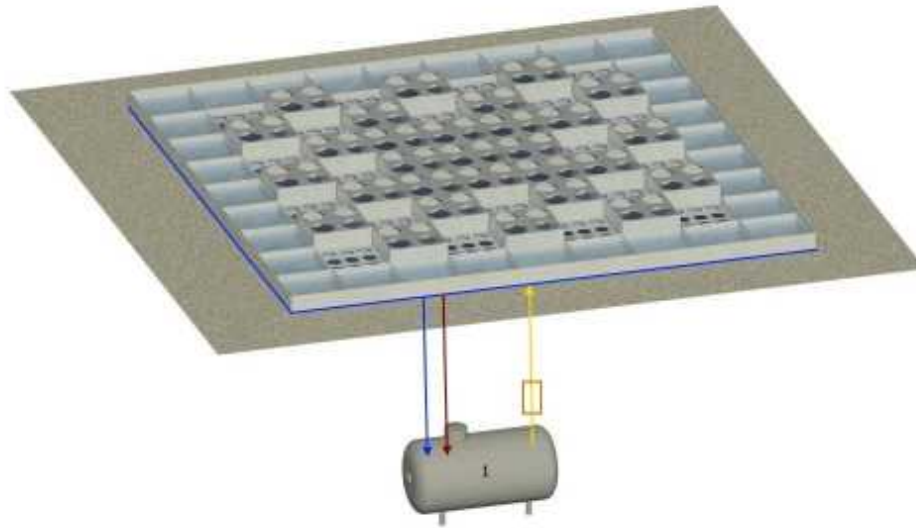







-  Stainless steel water basin, 13 cm high
-  Overflow drain + water basin
-  Full drain + water basin
-  Supplement irrigation + water basin
-  Optional: Water quality check plants + nutrient input
-  Rainwater reservoir / cistern incl. Filtration, without water purification

Fig. 3: Yard and Areal greening – water basin with installed **HPL® Planter Modules**



Fig. 4: Equipped **HPL® Planter Modules**



# Hydro Profi Line® Systems for Building Greenery: Indoor Water Supply & Areal Greening



**HPL® Systems for Building Greenery** – water supply for indoor greening (for details see page 7)



Areal greening indoors: Water basin with planted **HPL® Planter Modules**

With the **HPL® System for Building Greenery** areal indoor greening can be realized quickly and easily in any size and self-sustaining. As with all other **HPL® Systems for Building Greenery** you only require a water basin with at least 13 cm water level and the **HPL® Planter Modules**. The water basin can be installed in any shape and size on or embedded in the ground. Water and nutrients are supplied automatically via the **HPL® Irrigation System**, or independently through manual irrigation with freshwater. The areal greening also comes along with the reduction of water consumption by up to 80% compared to conventional greening. Any indoor plant in soil or hydroculture with any size can be used. With respect to the actual light and temperature conditions the plants are simply put into the **HPL® Planter Modules**. Thanks to the integrated **HPL® Quick Change System** individual plants can be exchanged or replaced selectively in every **HPL® Planter Module** without planting work.



# Hydro Profi Line® Systems for Building Greenery: Indoor Wall Greening Systems



Fig. 1: HPL® Wall Greening System are compatible with any indoor plant in soil or hydroculture

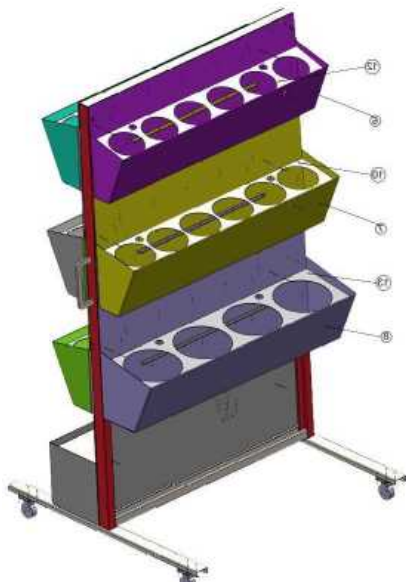

Fig. 2: Demonstration cart with three modules varying in depth



Fig. 4: HPL® Wall Greening Module

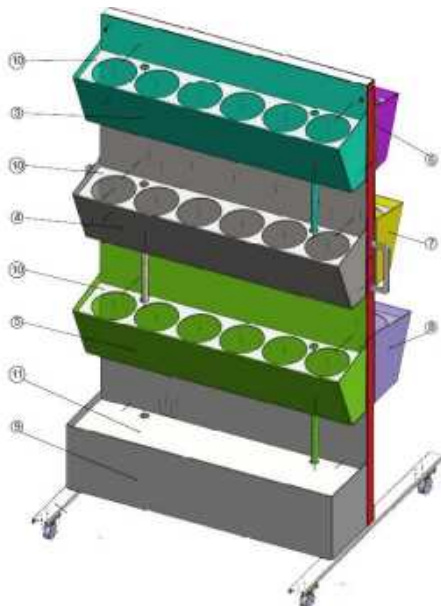

Fig. 3: Demonstration cart:  
Three HPL® Wall Greening Modules  
incl. irrigation tank at bottom

All HPL® Wall Greenings can be attached to the water circulation of the HPL® System for Building Greenery, making the greening self-sustaining with water and nutrients. All plants in soil and hydroculture can set into the system. Generally, the HPL® Wall Greening Modules are 100 cm in widths and available in three different depths for different plant sizes (see. Fig.2).

All HPL® Wall Greenings can as well be installed independently and without connection to the water circulation of the HPL® System for Building Greenery. In this case, the single elements are manually irrigated and supplied with nutrients every four to eight weeks. Alternatively, an irrigation tank is installed below the lowest element which supplies the elements of the greened wall regularly through a pump. In this case, only the irrigation tank needs to be refilled with water and nutrients.



## Hydro Profi Line® Systems for Building Greenery: Outdoor and Indoor Greening Modules



**HPL® Systems for Building Greenery** are developed on basis of the functionality of our patented **HPL® Planter Systems**. All modules for building greenery are made of high-quality and durable stainless steel. The **HPL® Modules for Building Greenery** for deployment in water basins consist of **HPL® Planter Modules** for intensive greening, **HPL® Areal Greening Modules** for intensive as well as extensive greening and **HPL® Footway and Area Correction Modules**.



**HPL® Planter Module Outdoors** for intensive greening



**HPL® Areal Greening Module Outdoors** for intensive and extensive greening



## Hydro Profi Line® Systems for Building Greenery: Outdoor and Indoor Greening Modules



**HPL® Planter Modules** for intensive greening:



All indoor and outdoor plant species in the desired size can be placed into the **HPL® Planter Modules** for intensive greening. Through the **HPL® Quick Change System** replacing and exchange of single plants is possible at any time and without planting works. **HPL® Planter Modules** for intensive greening are generally available in the following overall dimensions:

- Areal greening: 100 cm x 100 cm or 100 cm x 50 cm
- Balcony parapet greening: 80 cm x 25 cm or 100 cm x 25 cm
- Terrace greening: 90 cm x 40 cm or 120 cm x 40 cm

**HPL® Planter Modules** are offered in the designs with one special cultivation pot slots for solitary plants up to a height of 300 cm as well as with 25 special cultivation pot slots for small plants. The height of the **HPL® Planter Modules** depends on the size of the desired plant and the equivalent suitable **HPL® Special Cultivation Pot**. In addition to our range of standard planter modules we produce **HPL® Planter Modules** compatible to the desired plant in any size: For example for a chestnut tree with a height of 500 cm placed in a **HPL® Special Cultivation Pot** with 102 cm in diameter, 65 cm in height and the custom-made matching **HPL® Planter Module** in the dimensions 150 cm x 150cm and height of 78cm. Tell us your planting vision and we produce the matching **HPL® Planter Module** for every plant. All **HPL® Planter Modules** with any size can be combined and connected in area as desired.

Anti-theft device for cultivation pots

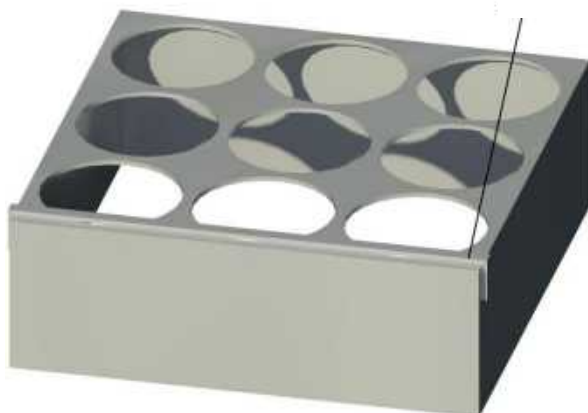

Anti-theft device for **HPL® Planter Module**



**HPL® Irrigation Wick**

To prevent plants in **HPL® Planter Modules** from theft and unauthorized removing in public areas all **HPL® Special Cultivation Pots** and **HPL® Planting Baskets** can be equipped with an anti-theft device.

To prevent new plants having root balls with poor root formation from withering **HPL® Special Cultivation Pots** can be equipped with an **HPL® Irrigation Wick** at the bottom prior to inserting new plants. The **HPL® Irrigation Wick** grants improved water access and additional water supply for new plants and improves root formation in the special cultivation pot.



## Hydro Profi Line® Systems for Building Greenery: Outdoor and Indoor Greening Modules



HPL® indoor Greening Modules



We produce all **HPL® Planter Modules** from high-quality and durable stainless steel. In addition to the **HPL® Planter Modules** we offer **HPL® Footway** and **Correction Modules**. The footway modules serve for walking and servicing of the greened area in the water basin and can be mounted at will between the planter modules. Generally, **HPL® Footway Modules** are 100 cm x 50 cm and 15 cm in height. The **HPL® Correction Modules** serve for exact fitting of the water basin area and are custom-made accordingly. The modules can be installed at the edge or between the planter and footway modules. **HPL® Footway** and **Correction Modules** are usually made of perforated stainless steel for ensuring the water uptake capability of the water basin outdoors in case of storm rainfall. All planter, footway and correction modules can be produced on demand with integrated built-in spotlights for illumination of the plants.



**HPL® Planter, Footway and Correction Modules** are positioned in the water basin according to the project planning and if required bolted together. For completion, the plants in the **HPL® Special Cultivation Pots** or **HPL® Planting Baskets** are simply put into the **HPL® Planter Modules** according to the greening layout. The low-maintenance and long-lasting greening is finished – without labor-intensive planting work and without the need for utilization of planting substrate. The greening now comes along with all other benefits of the patented **HPL® Planter Systems**.



## Hydro Profi Line® Systems for Building Greenery: Outdoor and Indoor Greening Modules



HPL® Areal Greening Modules for intensive and extensive greening:

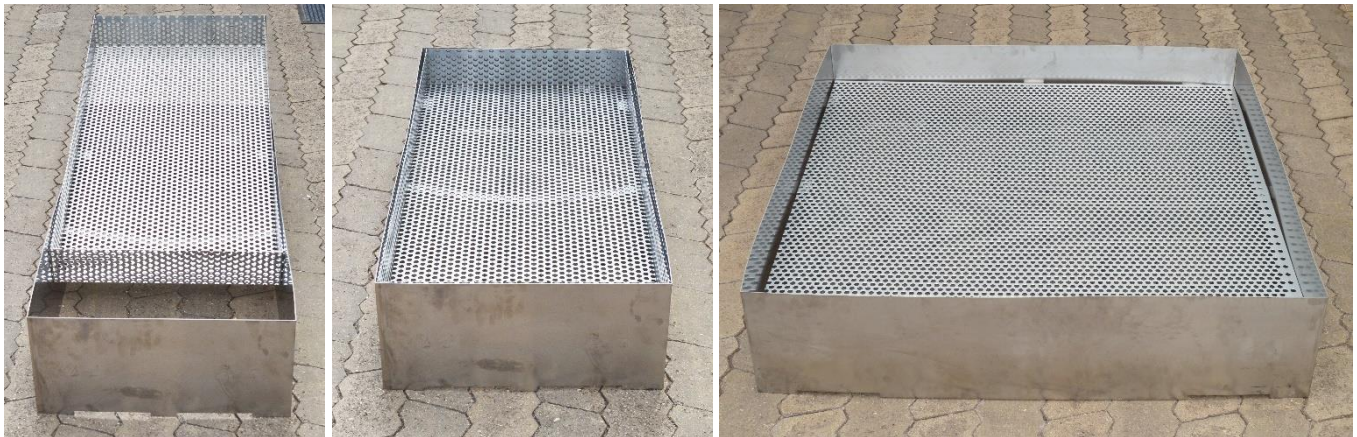

For intensive and extensive areal greening **HPL® Areal Greening Modules** are applied, consisting of a **HPL® Carrying Frame** and a **HPL® Planting Basket**. Both elements are made of high-quality and durable stainless steel. Generally, **HPL® Areal Greening Modules** are available in two sizes with the overall dimensions 100 cm x 100 cm and 100 cm x 50 cm – each with 28 cm in height. The planting depth of the **HPL® Planting Baskets** is 15 cm. Any planting substrate or granules like soil, Terraton, expanded clay etc. can be used and afterwards be planted with soil or hydroculture plants. All plants or compositions are possible appropriate to the site conditions like light and temperature. All areal greening flourishes splendidly with **HPL® Areal Greening Modules**, no matter if the **HPL® Planting Baskets** are combined with sod grass, mosses, sedum plants or ground-cover plants for outdoor greening, or ferns, orchids or ground-cover plants for indoor greening. Seeds from herbs, flowers or other plants can as well be used for cultivation in the **HPL® Planting Baskets**. Widely pre-planted **HPL® Planting Baskets** are also available for supply if wanted. After assembling, the **HPL® Planting Baskets** are simply put into the **HPL® Carrying Frames** floating over the bottom and that's it for the areal greening. Through integration into the **HPL® System for Building Greenery**, all irrigation or fertilization work is eliminated: The system is self-sustaining with rainwater. Moreover, the **HPL® Areal Greenings** come along with all other benefits of the patented HPL® Planter Systems.

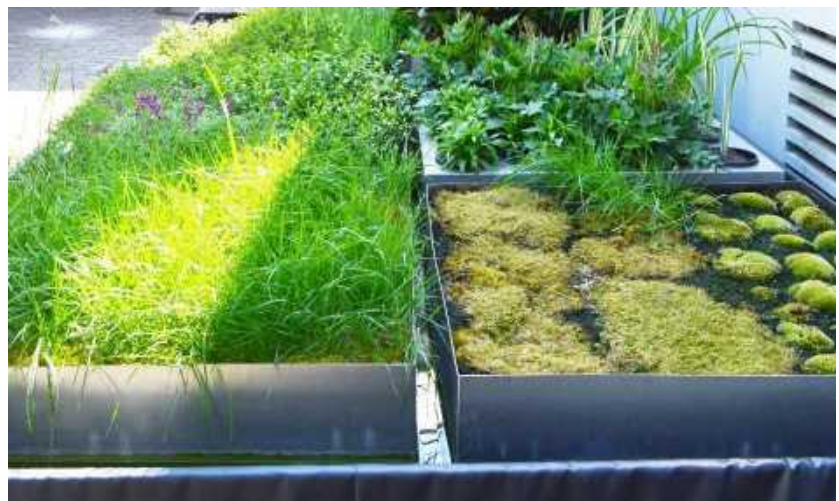

The greened **HPL® Planting Baskets** can be taken out of the **HPL® Carrying Frames** at any time, emptied out and positioned back with new plants. The high-quality **HPL® Planting Baskets** are reusable over and over.



## Hydro Profi Line® Systems for Building Greenery: Outdoor and Indoor Greening Modules



HPL® Stationary Modules for all solitary plants in any size:



Water basin greening with solitary plants



HPL® Stationary Module

**HPL® Stationary Modules** are produced compatible to the cultivation pot size at hand and weight of the applied solitary plant. For example: if you want to include an olive tree with 400 cm in height standing in a cultivation pot with 180 cm in diameter and weight of 2.000 kg into your greening concept, we custom make the **HPL® Stationary Module** matching these requirements. The stationary model is simply positioned in the water basin of the **HPL® System for Building Greenery** and the plant then lifted with a crane into the module. That's all for the desired greening without any labor-intensive planting work. If the removal of the plant becomes necessary for any reason, it can easily be lifted out of the **HPL® Stationary Module** the same way, even after years. Apropos, water basins with more than 13 cm of water can as well be applied for the case fish should be put into the basin or larger fountains installed. Even greening with swimming islands in e.g. lakes is possible without any irrigation work. Share your ideas with us and we fulfill your desires with **HPL® Planter Systems**.



A chestnut tree in the middle of a lake or providing shade in a floating beer-garden. Why not?







## Hydro Profi Line® Systems for Building Greenery: Outdoor and Indoor Greening Modules



HPL® Mobile Modules for all solitary plants in any size:



Pachira in HPL® Mobile Module



Clusia in HPL® Mobile module

Like **HPL® Stationary Modules** we produce **HPL® Mobile Modules** appropriate to the size and weight of the desired solitary plant. When applying **HPL® Mobile Modules** on rollers for water basin greening the plant can be easily relocated whenever you want within the water basin without extra effort. Additionally, through the mobility feature all work like inserting or replacement of heavy plants and plant care work is extremely simplified as it can be carried out at the basin edge. Subsequently the plant can be pushed back to the desired location. As usual, all **HPL® Stationary** and **Mobile Modules** are made of stainless steel. Of course, all **HPL® Greening Modules** can be supplied coated in any RAL color. Add-on modules like built-in spotlights for illumination of the plants, surveillance cameras, sound systems and many more can be integrated into the **HPL® Planter Modules** depending on the demands. Tell us your requirements and we find the appropriate solution.

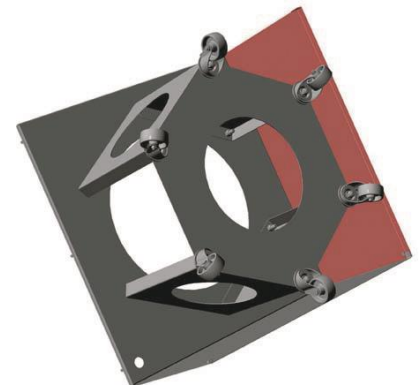

We produce **HPL® Mobile Modules** suited for solitary plants in any size and for any weight.



## Hydro Profi Line® Systems for Areal Greenery



Enabling intensive urban greening – convenient & cost-effective.

**Applied in form of planting islands for pedestrian zones:**

The illustrations display HPL® System Feet with HPL® System Girders and HPL® Water basins with integrated HPL® Modul Systems prepared for a planting island.



Arranged as faced planting island.



... almost no limits for combination, expansion, and modification. Bringing GREEN into our cities.



## Hydro Profi Line® Systems for Areal Greenery



Enabling intensive urban greening – convenient & cost-effective.

### Applied in form of planting islands for pedestrian zones:

The illustrations display HPL® Areal Greening Modules arranged and faced in different ways. The facing can be designed as desired and the various alternatives can as well be installed indoors.

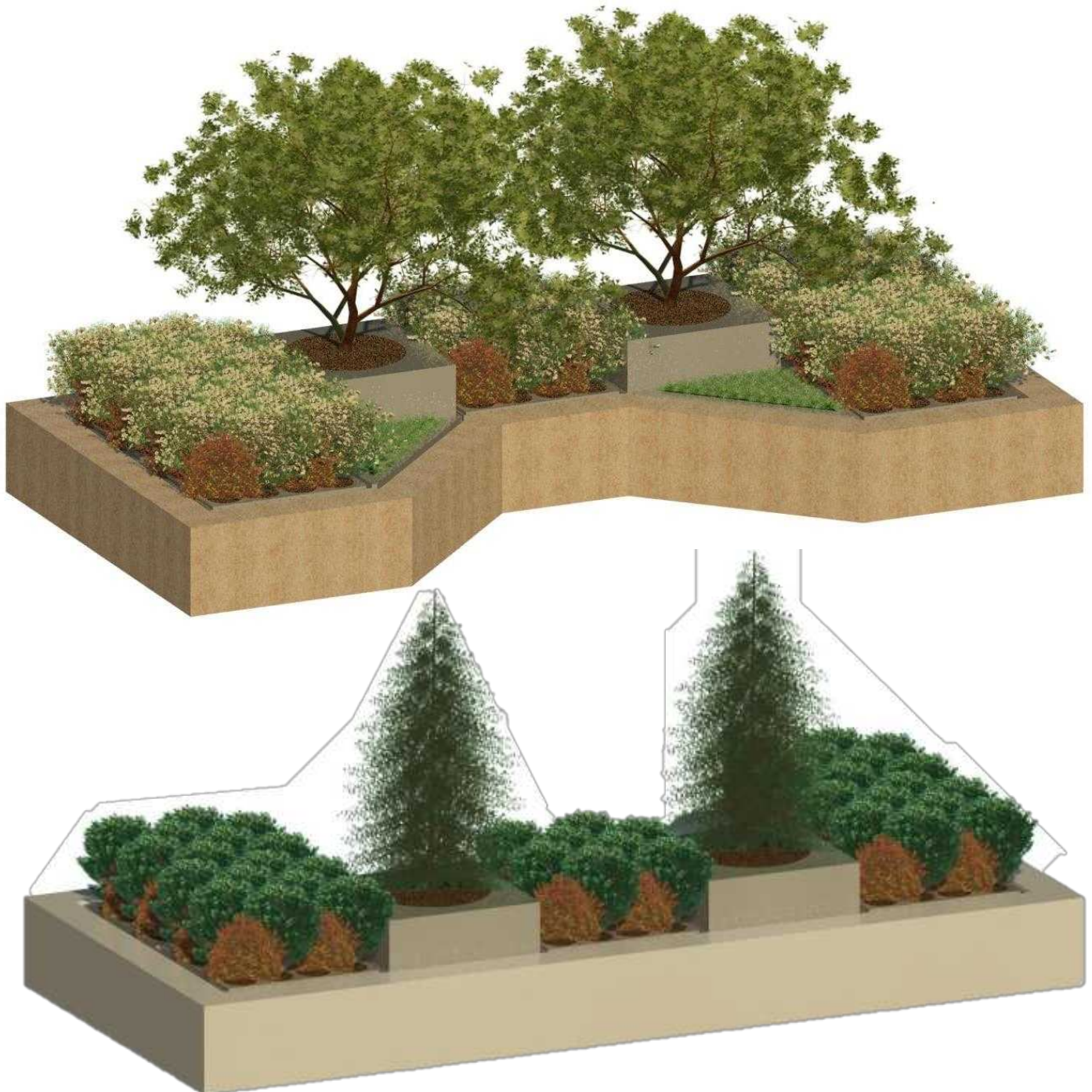

All demands regarding greening and layout designs can be implemented quickly and easily – at lowest maintenance and servicing effort.

... almost no limits for combination, expansion, and modification. Bringing GREEN into our cities.



## Hydro Profi Line® Systems for Areal Greenery



Enabling intensive urban greening – convenient & cost-effective.

**Applied in form of a roof greening system for carports:**

The illustration displays HPL® Modul Systems installed and planted on carport roofs.



HPL® Modul systems are made of premium stainless steel for long-term durable, well-functioning and low-maintenance greenery. All plants flourish splendidly in HPL® planter systems and require up to 80% less water compared to conventional planter systems.

Fundamentally new designs become possible for all committed architects, property developers and landscape gardeners – and anybody else.

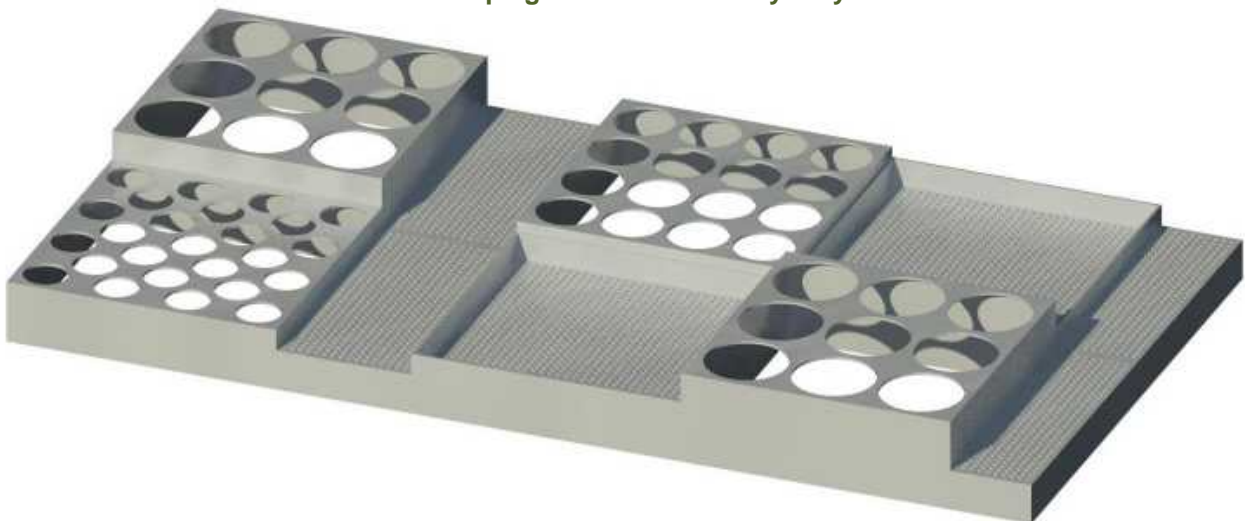

... almost no limits for combination, expansion, and modification. Bringing GREEN into our cities.



## Hydro Profi Line® Systems for Areal Greenery



Enabling intensive urban greening – convenient & cost-effective.

**Applied in form of a roof greening system for sheds and outbuildings:**

The illustration displays HPL® Modul systems installed and planted on the roof of a waste shed.



HPL® Systems for Areal Greenery are applicable to all impervious surfaces and have almost no limitations in terms of combinations, expansions, and modifications. For a roof greening with long-term rainwater supply, the sole requirement is as water basin with a water level of 10 to 13 cm. Even blooming seasonal plants or herbs are compatible and can be exchanged at any time without planting work thanks to the Quick Change System.

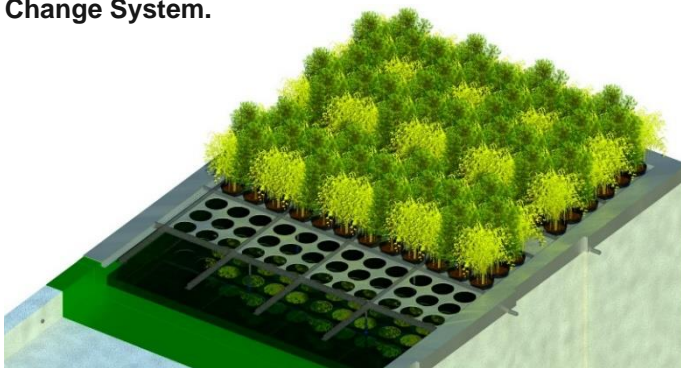

**Only three steps to a perfect greenery:**

1. Connect HPL® System Feet with HPL® System Girders in the water basin and adjust for unevenness.
2. Deploy HPL® System Plates and/or pre-greened HPL® System baskets.
3. Position plants in HPL® Cultivation Pots into the HPL® System Plates.  
The greening is complete!

... almost no limits for combination, expansion, and modification. Bringing GREEN into our cities.



## Hydro Profi Line® Systems for Areal Greenery



Enabling intensive urban greening – convenient & cost-effective.

### Applied in form of a roof greening system for a public transport stop:

The illustration displays HPL® Modul Systems installed and planted on a public transport stop.



### Applied in form of a terrace and balcony greening system:

The illustration displays HPL® Modul Systems installed and planted on a balcony.



Hydro Profi Line® Module Systems in stainless steel troughs are easily installed on any balcony or terrace. When integrated into the Hydro Profi Line® System for Building Greenery the plants are supplied automatically with rainwater and do not need to be irrigated additionally. With the help of the integrated Quick Change System single plants can be exchanged or replaced at any time without the usual planting work.

... almost no limits for combination, expansion, and modification. Bringing GREEN into our cities.



## Hydro Profi Line® Systems for Areal Greenery



Enabling intensive urban greening – convenient & cost-effective.

### Applied in form of an indoor greening system:

The illustration displays HPL® Modul systems installed and equipped with plants indoors.



The Hydro Profi Line® Water Basin System allows for a modular and flexible connection of any number of single basins on plane surfaces – without overflow functionality for indoors, with overflow functionality for outdoors. Due to the modular construction kit characteristics of the system, any shape and size can be designed quickly and easily. Finally, the HPL® Module Systems are deployed into the water basins according to the desired greening. The basins are made of stainless steel and can be ordered in any RAL color (mat or glossy). Alternatively, you face the basin and modules matching the surrounding with the desired material and design.



... almost no limits for combination, expansion, and modification. Bringing GREEN into our cities.



# Hydro Profi Line® Greening Modules for Outdoors and Indoors



## HPL® Cultivation Pot Modules

## HPL® Special Cultiv. Pot



*in cm*

Size: 100 x 100 x 23,5 (variable)  
Cultivation pots: 25 pc. x 2,0 liters  
Material: stainless steel

EAN code: 4260369985110



size: 2,0 liters

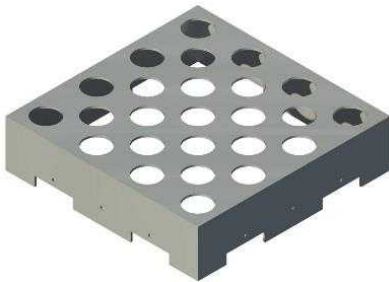

*in cm*

Size: 100 x 100 x 24,5 (variable)  
Cultivation pots: 25 pc. x 1,3 liters  
Material: stainless steel

EAN code: 4260369985127

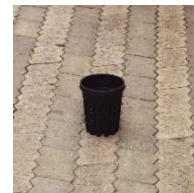

size: 1,3 liters



*in cm*

Size: 100 x 100 x 25,0 (variable)  
Cultivation pots: 16 pc. x 3,0 liters  
Material: stainless steel

EAN code: 4260369985103

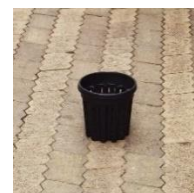

size: 3,0 liters

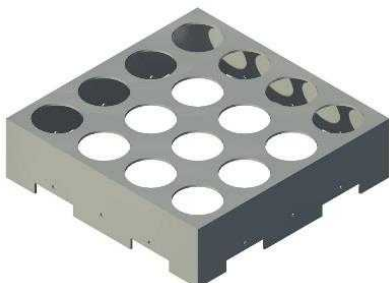

*in cm*

Size: 100 x 100 x 26,5 (variable)  
Cultivation pots: 16 pc. x 3,5 liters  
Material: stainless steel

EAN code: 4260369985097

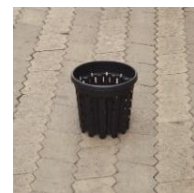

size: 3,5 liters

*Note: The height of the modules is produced according to the planned water level in the planting basins.  
The height of the standard modules fits water basins with 13 cm water level.*







# Hydro Profi Line® Greening Modules for Outdoors and Indoors



## HPL® Cultivation Pot Modules

## HPL® Special Cultiv. Pot

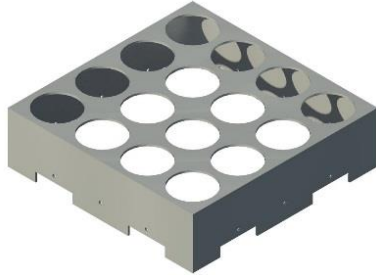

*in cm*

Size: 100 x 100 x 27,5 (variable)  
Cultivation pots: 16 pc. x 5,0 liters  
Material: stainless steel

EAN code: 4260369985080



size: 5,0 liters



*in cm*

Size: 100 x 100 x 29,0 (variable)  
Cultivation pots: 9 pc. x 7,5 liters  
Material: stainless steel

EAN code: 4260369985073



size: 7,5 liters



*in cm*

Size: 100 x 100 x 30,5 (variable)  
Cultivation pots: 9 pc. x 9,5 liters  
Material: stainless steel

EAN code: 4260369985066



size: 9,5 liters



*in cm*

Size: 100 x 100 x 32,0 (variable)  
Cultivation pots: 9 pc. x 12,0 liters  
Material: stainless steel

EAN code: 4260369985059



size: 12,0 liters

*Note: The height of the modules is produced according to the planned water level in the planting basins.  
The height of the standard modules fits water basins with 13 cm water level.*





# Hydro Profi Line® Greening Modules for Outdoors and Indoors



## HPL® Cultivation Pot Modules

## HPL® Special Cultiv. Pot

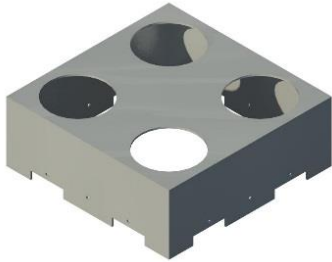

*in cm*

Size: 100 x 100 x 37 (variable)  
Cultivation pots: 4 pc. x 25 liters  
Material: stainless steel

EAN code: 4260369985042



size: 25 liters

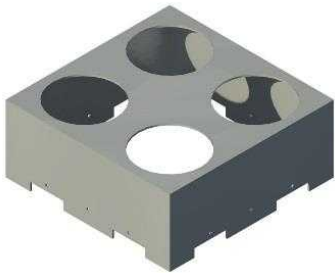

*in cm*

Size: 100 x 100 x 41 (variable)  
Cultivation pots: 4 pc. x 35 liters  
Material: stainless steel

EAN code: 4260369985035



size: 35 liters

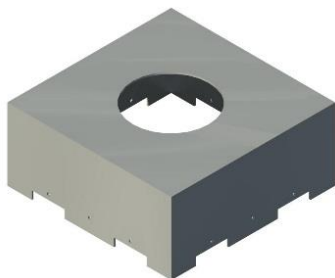

*in cm*

Size: 100 x 100 x 44 (variable)  
Cultivation pots: 1 pc. x 50 liters  
Material: stainless steel

EAN code: 4260369985028

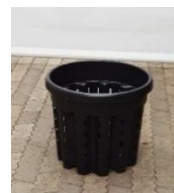

size: 50 liters

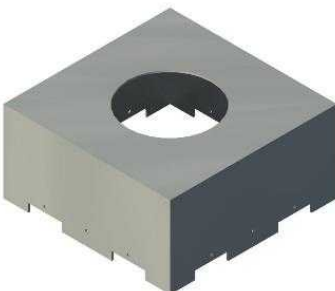

*in cm*

Size: 100 x 100 x 49 (variable)  
Cultivation pots: 1 pc. x 70 liters  
Material: stainless steel

EAN code: 4260369985011



size: 70 liters

*Note: The height of the modules is produced according to the planned water level in the planting basins.  
The height of the standard modules fits water basins with 13 cm water level.*





# Hydro Profi Line® Greening Modules for Outdoors and Indoors



## HPL® Cultivation Pot Modules

## HPL® Special Cultiv. Pot

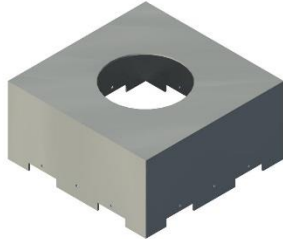

*in cm*

Size: 100 x 100 x 50 (variable)  
Cultivation pots: 1 pc. x 90 liters  
Material: stainless steel

EAN code: 4260369985004



size: 90 liters

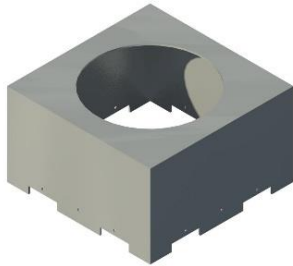

*in cm*

Size: 100 x 100 x 58 (variable)  
Cultivation pots: 1 pc. x 180 liters  
Material: stainless steel

EAN code: 4260369984991



size: 180 liters

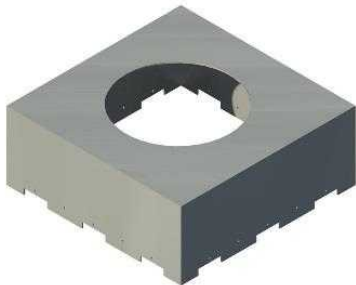

*in cm*

Size: 150 x 150 x 59 (variable)  
Cultivation pots: 1 pc. x 285 liters  
Material: stainless steel

EAN code: 4260369984984



size: 285 liters

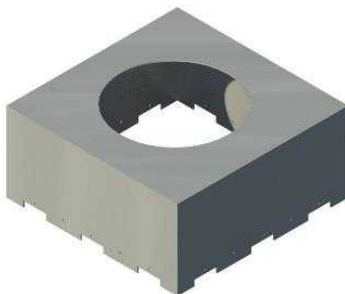

*in cm*

Size: 150 x 150 x 70 (variable)  
Cultivation pots: 1 pc. x 375 liters  
Material: stainless steel

EAN code: 4260369984977



size: 375 liters

Note: The height of the modules is produced according to the planned water level in the planting basins. The height of the standard modules fits water basins with 13 cm water level.





# Hydro Profi Line® Greening Modules for Outdoors and Indoors



## HPL® Cultivation Pot Modules

## HPL® Special Cultiv. Pot



*in cm*

Size: 100 x 50 x 23,5 (variable)  
Cultivation pots: 11 pc. x 2,0 liters  
Material: stainless steel

EAN code: 4260369985219



size: 2,0 liters



*in cm*

Size: 100 x 50 x 24,5 (variable)  
Cultivation pots: 11 pc. x 1,3 liters  
Material: stainless steel

EAN code: 4260369985226

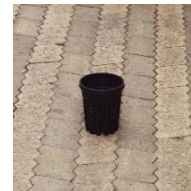

size: 1,3 liters



*in cm*

Size: 100 x 50 x 25,0 (variable)  
Cultivation pots: 8 pc. x 3,0 liters  
Material: stainless steel

EAN code: 4260369985202

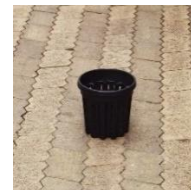

size: 3,0 liters

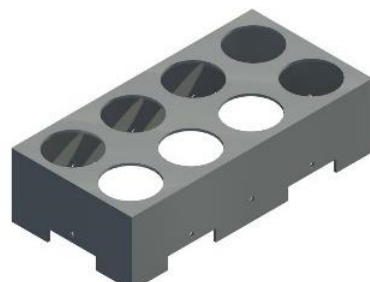

*in cm*

Size: 100 x 50 x 26,5 (variable)  
Cultivation pots: 8 pc. x 3,5 liters  
Material: stainless steel

EAN code: 4260369985196

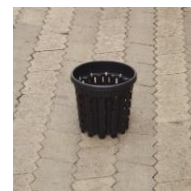

size: 3,5 liters

*Note: The height of the modules is produced according to the planned water level in the planting basins.  
The height of the standard modules fits water basins with 13 cm water level.*





# Hydro Profi Line® Greening Modules for Outdoors and Indoors



## HPL® Cultivation Pot Modules

## HPL® Special Cultiv. Pot



*in cm*

Size: 100 x 50 x 27,5 (variable)  
Cultivation pots: 8 pc. x 5,0 liters  
Material: stainless steel

EAN code: 4260369985189



size: 5,0 liters

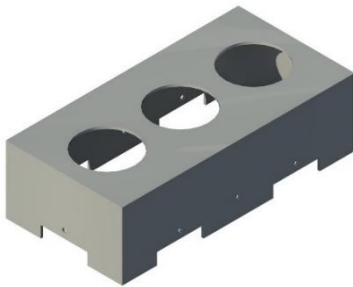

*in cm*

Size: 100 x 50 x 29,0 (variable)  
Cultivation pots: 3 pc. x 7,5 liters  
Material: stainless steel

EAN code: 4260369985172



size: 7,5 liters



*in cm*

Size: 100 x 50 x 30,5 (variable)  
Cultivation pots: 3 pc. x 9,5 liters  
Material: stainless steel

EAN code: 4260369985165



size: 9,5 liters

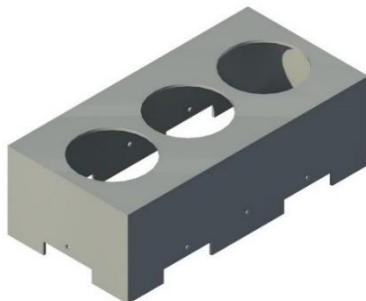

*in cm*

Size: 100 x 50 x 32,0 (variable)  
Cultivation pots: 3 pc. x 12,0 liters  
Material: stainless steel

EAN code: 4260369985158



size: 12,0 liters

Note: The height of the modules is produced according to the planned water level in the planting basins.  
The height of the standard modules fits water basins with 13 cm water level.





# Hydro Profi Line® Greening Modules for Outdoors and Indoors



## HPL® Cultivation Pot Modules

## HPL® Special Cultiv. Pot

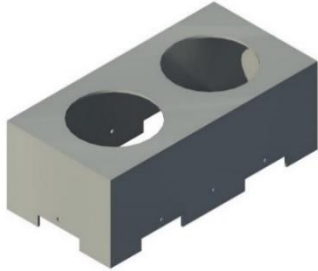

*in cm*

Size: 100 x 50 x 37 (variable)  
Cultivation pots: 2 pc. x 25 liters  
Material: stainless steel

EAN code: 4260369985141



size: 25 liters

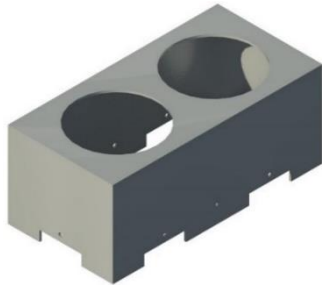

*in cm*

Size: 100 x 50 x 41 (variable)  
Cultivation pots: 2 pc. x 35 liters  
Material: stainless steel

EAN code: 4260369985134



size: 35 liters

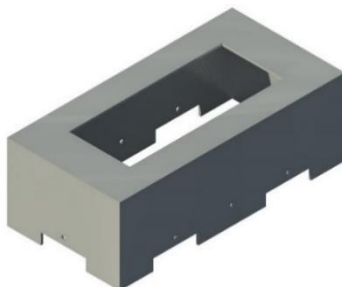

*in cm*

Size: 100 x 50 x 34 (variable)  
Cultivation pots: 1 pc. x 45 liters  
Material: stainless steel

EAN code: 4260369985233



size: 45 liters

*Note: The height of the modules is produced according to the planned water level in the planting basins.  
The height of the standard modules fits water basins with 13 cm water level.*

All HPL® Greening Modules for outdoors and indoors can be produced with a fixation bar to protect the HPL® Special Cultivation Pots from storm loads or unauthorized removal:

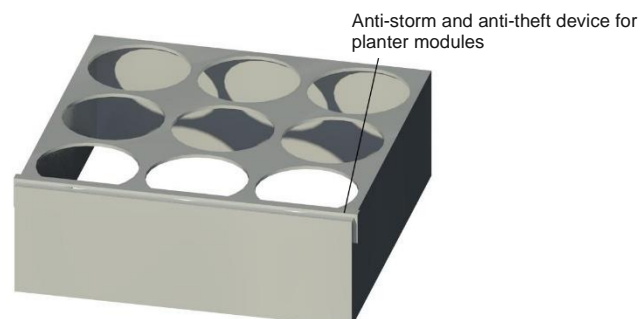



# Hydro Profi Line® Greening Modules for Outdoors and Indoors



## HPL® Cultivation Pot Modules for balcony and parapet greenery

## HPL® Special Cultiv. Pot



*in cm*

Size: 100 x 20 x 23,5 (variable)  
Cultivation pots: 5 pc. x 2,0 liters  
Material: stainless steel

EAN code: 4260369985257



size: 2,0 liters



*in cm*

Size: 100 x 20 x 24,5 (variable)  
Cultivation pots: 6 pc. x 1,3 liters  
Material: stainless steel

EAN code: 4260369985264

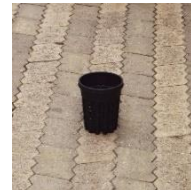

size: 1,3 liters



*in cm*

Size: 100 x 22 x 25,0 (variable)  
Cultivation pots: 5 pc. x 3,0 liters  
Material: stainless steel

EAN code: 4260369985240

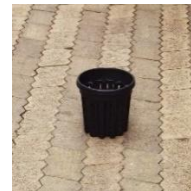

size: 3,0 liters

**All HPL® Modules are made of premium stainless steel.**



**HPL® Modules powder-coated with built-in spotlights standing in water basins.**

HPL® Modules can be produced in any other desired shape and size according to the respective utilization purpose. Share your ideas with us, we make them a reality.





# Hydro Profi Line® Greening Modules for Outdoors and Indoors



## HPL® Planting Basket Modules

## HPL® Planting Baskets Set

*in cm*

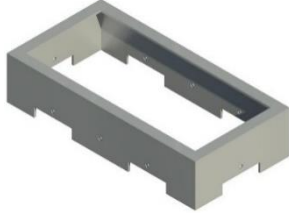

Frame size: 100 x 50 x 21,5 (variable)  
Planting basket size: 100 x 50 x 11,5  
Material: stainless steel

Set-EAN code: 4260369985288  
Module-EAN code: 4260369985363  
Basket-EAN code: 4260369961435

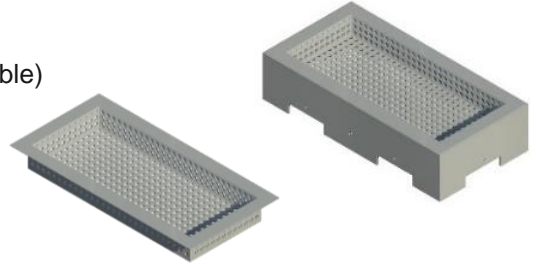

*in cm*

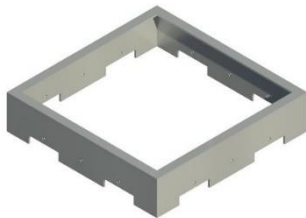

Frame size: 100 x 100 x 21,5 (variable)  
Planting basket size: 100 x 100 x 11,5  
Material: stainless steel

Set-EAN code: 4260369985271  
Module-EAN code: 4260369985356  
Basket-EAN code: 4260369961442

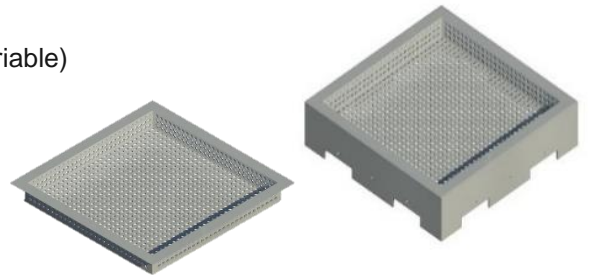

*in cm*



Frame size: 100 x 100 x 141,4 x 21,5 (variable)  
Planting basket size: 100 x 100 x 141,4 x 11,5  
Material: stainless steel

Set-EAN code: 4260369982584  
Module-EAN code: 4260369985370  
Basket-EAN code: 4260369961428



*in cm*

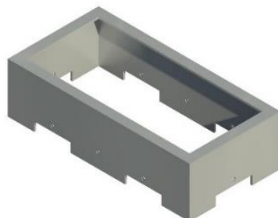

Frame size: 100 x 50 x 26,5 (variable)  
Planting basket size: 100 x 50 x 16,5  
Material: stainless steel

Set-EAN code: 4260369985349  
Module-EAN code: 4260369985394  
Basket-EAN code: 4260369985424

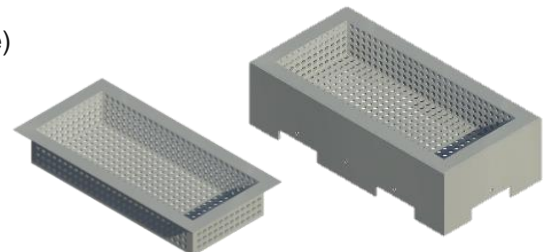

*Note: The height of the modules is produced according to the planned water level in the planting basins.  
The height of the standard modules fits water basins with 13 cm water level.*







# Hydro Profi Line® Greening Modules for Outdoors and Indoors



## HPL® Planting Basket Modules

## HPL® Planting Baskets

## Set

*in cm*

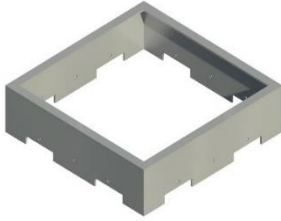

Frame size: 100 x 100 x 26,5  
 Planting basket size: 100 x 100 x 16,5  
 Material: stainless steel

Set-EAN code: 4260369985295  
 Module-EAN code: 4260369985387  
 Basket-EAN code: 4260369961411

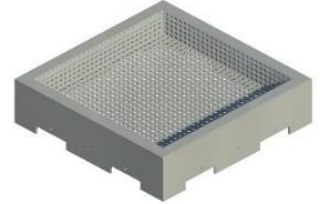
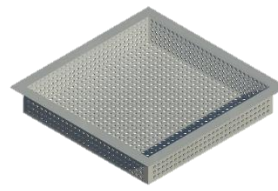

*in cm*



Frame size: 100 x 100 x 141,4 x 26,5  
 Planting basket size: 100 x 100 x 141,4 x 16,5  
 Material: stainless steel

Set-EAN code: 4260369985417  
 Module-EAN code: 4260369985400  
 Basket-EAN code: 4260369985431



*Note: The height of the modules is produced according to the planned water level in the planting basins.  
 The height of the standard modules fits water basins with 13 cm water level.*

## HPL® Water Basins for HPL® Planting Baskets

*in cm*



Frame size: 105 x 105 x 27,0  
 Planting basket size: 100 x 100 x 16,5  
 Material: stainless steel

Basin-EAN code: 4260369985448  
 Basket-EAN code: 4260369961411

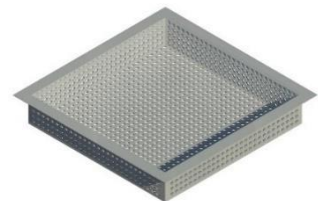

*in cm*



Frame size: 105 x 105 x 148,5 x 27,0  
 Planting basket size: 100 x 100 x 141,4 x 16,5  
 Material: stainless steel

Basin-EAN code: 4260369985462  
 Basket-EAN code: 4260369985431





# Hydro Profi Line® Greening Modules for Outdoors and Indoors



## HPL® Water Basins for HPL® Planting Baskets

*in cm*



Basin size: 105 x 52,5 x 27  
Planting basket size: 100 x 50 x 16,5  
Material: stainless steel

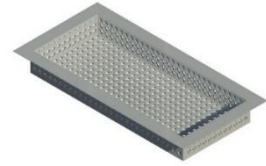

Basin-EAN code: 4260369985455  
Basket-EAN code: 4260369985424

---

## HPL® Water Basins without carrying edge for HPL® Cultivation Pot Modules

*in cm*



Basin size: 105 x 105 x 27  
Material: stainless steel

EAN code: 4260369985479

---

*in cm*



Basin size: 105 x 105 x 148,5 x 27  
Material: stainless steel

EAN code: 4260369985493

---

*in cm*



Basin size: 105 x 52,5 x 27  
Material: stainless steel

EAN code: 4260369985486

---

*in cm*



Basin size: 160 x 160 x 16  
Material: stainless steel

EAN code: 4260369985509





# Hydro Profi Line® Greening Modules for Outdoors and Indoors



## Hydro Profi Line® Planting baskets

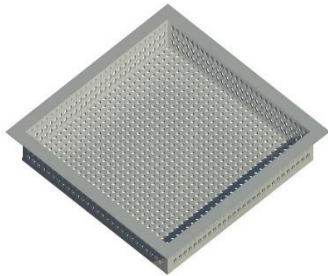

*in cm*

Planting basket size: 100 x 100 x 11,5  
Material: stainless steel

EAN code: 4260369961442

---

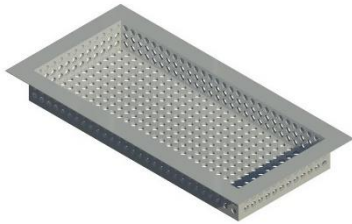

*in cm*

Planting basket size: 100 x 50 x 11,5  
Material: stainless steel

EAN code: 4260369961435

---



*in cm*

Planting basket size: 100 x 100 x 141,4 x 11,5  
Material: stainless steel

EAN code: 4260369961428

---

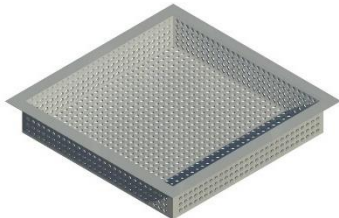

*in cm*

Planting basket size: 100 x 100 x 16,5  
Material: stainless steel

EAN code: 4260369961411

---



*in cm*

Planting basket size: 100 x 50 x 16,5  
Material: stainless steel

EAN code: 4260369985424

---

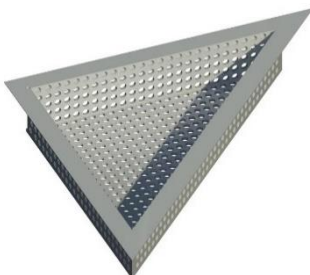

*in cm*

Planting basket size: 100 x 100 x 141,4 x 16,5  
Material: stainless steel

EAN code: 4260369985431





# Hydro Profi Line® Greening Modules for Outdoors and Indoors



## Hydro Profi Line® Footway and Supply Modules



*in cm*

Size: 100 x 50 x 16  
Material: stainless steel  
EAN code: 4260369985301



---

*in cm*

Size: 100 x 50 x 16  
with a hole for installation of LED spotlights  
Material: stainless steel  
EAN code: 4260369985318



---

*in cm*

Size: 150 x 50 x 16  
Material: stainless steel  
EAN code: 4260369985325

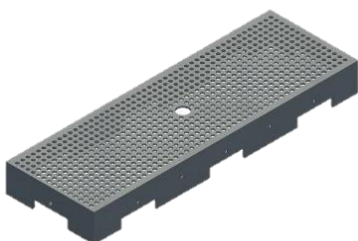

---

*in cm*

Size: 150 x 50 x 16  
with a hole for installation of LED spotlights  
Material: stainless steel  
EAN code: 4260369985332





# Hydro Profi Line® Greening Modules for Outdoors and Indoors



## Hydro Profi Line® Grid for Roof and Areal Greenery

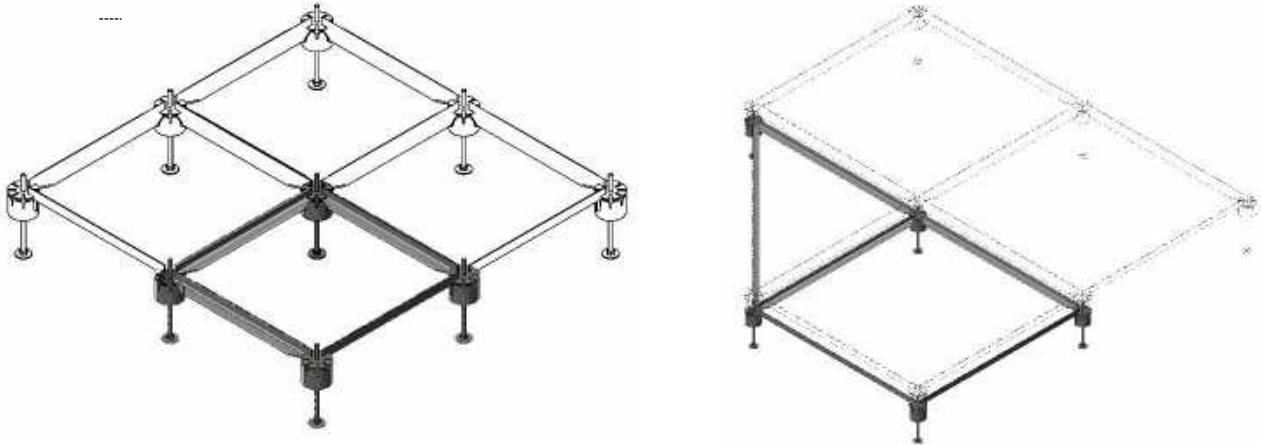

The newly developed HPL® Grid System creates numerous combination possibilities and can be almost infinitely expanded. The unique HPL® Feet are adjustable for height to balance uneven surfaces quickly and easily. With the easy installation and flexibility for required adjustments, large size areal greening ventures and durable planting islands with long-term functionality and minimal maintenance effort can become reality. Moreover, existing impervious surfaces now become a potential site for intensive greening – without affecting the built structure.

### Hydro Profi Line® Grid System Components



#### HPL® Grid Connection Feet

Material: stainless steel  
Size: height-adjustable  
EAN code: 4260369985905



#### HPL® Grid Connection Girders

X-girder  
Material: galvanized steel  
Length: 50 cm  
EAN code: 4260369985516



X-girder  
Material: galvanized steel  
Length: 100 cm  
EAN code: 4260369985523



X-girder  
Material: galvanized steel  
Length: 140 cm  
EAN code: 4260369985530





# Hydro Profi Line® Greening Modules for Outdoors and Indoors



## Hydro Profi Line® Grid System for Roof and Areal Greenery



Planting island set up from the HPL® Grid System combined with HPL® Water Basins, HPL® Modules and HPL® Planting Baskets.



Application of the HPL® Grid System for a planting island



Through its modularity and flexibility, the grid systems create numerous possibilities for creative solutions.

### HPL® Grid Connection Girders



L-girder  
Material: galvanized steel  
Length: 50 cm  
EAN code: 4260369985547



L-girder  
Material: galvanized steel  
Length: 100 cm  
EAN code: 4260369985554



L-girder  
Material: galvanized steel  
Length: 140 cm  
EAN code: 4260369985561





# Hydro Profi Line® Greening Modules for Outdoors and Indoors



## Hydro Profi Line® Grid System for Roof and Areal Greenery



The HPL® Grid System can be extended as desired and creates many possibilities for combination in the areal design. The grid system can be deployed indoors as well as outdoors for any greening desire.

### HPL® System Plates for HPL® Grid System

### HPL® Special Cultiv. Pot



*in cm*

System plate size: 105 x 52,5  
Cultivation pots: 11 pc. x 2,0 liters  
Material: stainless steel  
EAN code: 4260369985578



size: 2,0 liters



*in cm*

System plate size: 105 x 52,5  
Cultivation pots: 11 pc. x 1,3 liters  
Material: stainless steel  
EAN code: 4260369985585

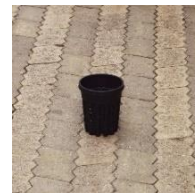

size: 1,3 liters



*in cm*

System plate size: 105 x 52,5  
Cultivation pots: 8 pc. x 3,0 liters  
Material: stainless steel  
EAN code: 4260369985592

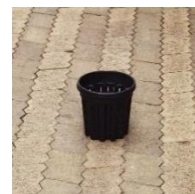

size: 3,0 liters



*in cm*

System plate size: 105 x 52,5  
Cultivation pots: 8 pc. x 3,5 liters  
Material: stainless steel  
EAN code: 4260369985608

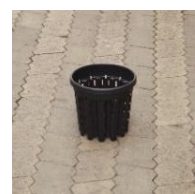

size: 3,5 liters





# Hydro Profi Line® Greening Modules for Outdoors and Indoors



## Hydro Profi Line® Grid System for Roof and Areal Greenery

The innovative HPL® Grid System can be positioned in any basin and is adjustable to the respective water level and uneven surfaces. Through the easy deployment of the HPL® System Plates and Baskets in the grid modules, even large basins can be quickly prepared for the greenery. All advantages of the HPL® Planter System come along.

### HPL® System Plate for HPL® Grid System

### HPL® Special Cultiv. Pot

	<p><i>in cm</i></p> <p>System plate size: 105 x 105            Cultivation pots: 25 pc. x 2,0 liters            Material: stainless steel</p> <p>EAN code: 4260369985615</p>	
	<p><i>in cm</i></p> <p>System plate size: 105 x 105            Cultivation pots: 25 pc. x 1,3 liters            Material: stainless steel</p> <p>EAN code: 4260369985622</p>	
	<p><i>in cm</i></p> <p>System plate size: 105 x 105            Cultivation pots: 16 pc. x 3,0 liters            Material: stainless steel</p> <p>EAN code: 4260369985639</p>	
	<p><i>in cm</i></p> <p>System plate size: 105 x 105            Cultivation pots: 16 pc. x 3,5 liters            Material: stainless steel</p> <p>EAN code: 4260369985646</p>	







# Hydro Profi Line® Greening Modules for Outdoors and Indoors



## Hydro Profi Line® Grid System for Roof and Areal Greenery

### HPL® System Plates for the HPL® Grid System to carry HPL® Planting Baskets

### HPL® Planting Baskets

*in cm*

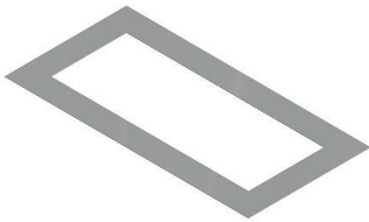

System plate size: 105 x 52,5  
Planting basket size: 100 x 50 x 16,5  
Material: stainless steel

Set-EAN code: 4260369985684  
Plate-EAN code: 4260369985653  
Basket-EAN code: 4260369985424



*in cm*

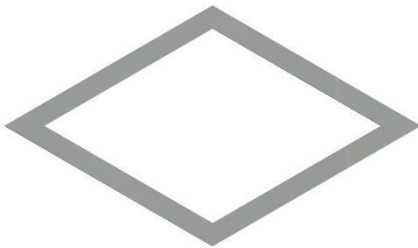

System plate size: 105 x 105  
Planting basket size: 100 x 100 x 16,5  
Material: stainless steel

Set-EAN code: 4260369985691  
Plate-EAN code: 4260369985660  
Basket-EAN code: 4260369961411

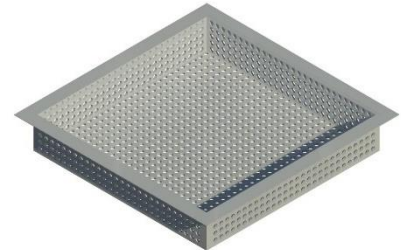

*in cm*

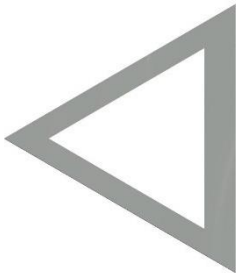

System plate size: 105 x 105 x 146,4  
Planting basket size: 100 x 100 x 141,4 x 16,5  
Material: stainless steel

Set-EAN code: 4260369985707  
Plate-EAN code: 4260369985677  
Basket-EAN code: 4260369985431

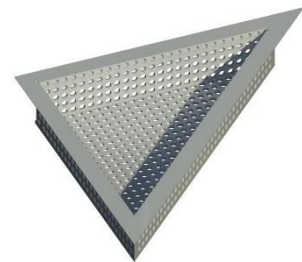

### HPL® Walkway Module for HPL® Grid System

*in cm*



Size: 105 x 52,5  
Material: stainless steel

EAN code: 4260369985714

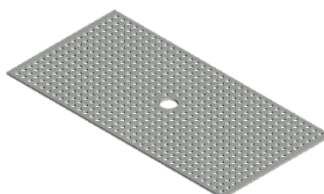

With hole for installation of LED spotlights

EAN code: 4260369985721





# Hydro Profi Line® Greening Modules for Outdoors and Indoors



**HPL® Wall Greening Modules with independent water circulation alternatively, for integration into the HPL® System for Building Greenery**

## HPL® Wall- and Facade Greening Modules

## HPL® Special Cultiv. Pot



*in cm*

Module size: width 100 - depth 17,5  
 Rear cover height: variable, from 36 cm to 75 cm  
 Cultivation pots: 6 pc. x 1,3 liters  
 Material: stainless steel

EAN code: 4260369985738



size: 1,3 liters



*in cm*

Module size: width 100 - depth 21,0  
 Rear cover height: variable, from 36 cm to 75 cm  
 Cultivation pots: 6 pc. x 2,0 liters  
 Material: stainless steel

EAN code: 4260369985745



size: 2,0 liters



*in cm*

Module size: width 100 - depth 31,5  
 Rear cover height: variable, from 45 cm to 100 cm  
 Cultivation pots: 4 pc. x 3,0 liters  
 Material: stainless steel

EAN code: 4260369985776

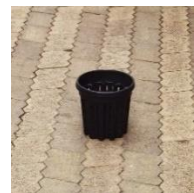

size: 3,0 liters

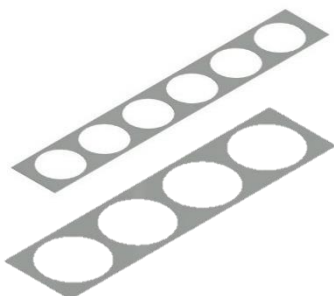

## Hydro Profi Line® System Plates



**Mounted modules made of powder-coated steel**

*Note: All wall and facade greening modules are available as custom-made product in any desired width up to 200 cm.*

**On-demand:** modules made of powder-coated steel (mat or glossy), in desired RAL-color.





# Hydro Profi Line® Greening Modules for Outdoors and Indoors



## HPL® Wall and Facade Greening Modules

## HPL® Special Cultiv. Pot

*in cm*



Module size: width 100 - depth 17,5  
Rear cover height: variable, from 36 cm to 75 cm  
Cultivation pots: 6 pc. x 1,3 liters  
Material: stainless steel

EAN code: 4260369982751



size: 1,3 liters

*in cm*



Module size: width 100 - depth 21,0  
Rear cover height: variable, from 36 cm to 75 cm  
Cultivation pots: 6 pc. x 2,0 liters  
Material: stainless steel

EAN code: 4260369961381

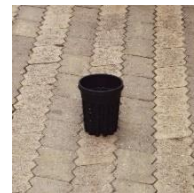

size: 2,0 liters

*in cm*



Module size: width 100 - depth 31,5  
Rear cover height: variable, from 45 cm to 100 cm  
Cultivation pots: 4 pc. x 3,0 liters  
Material: stainless steel

EAN code: 4260369985769

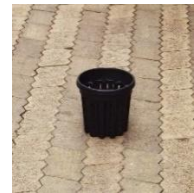

size: 3,0 liters

## Hydro Profi Line® System Plates

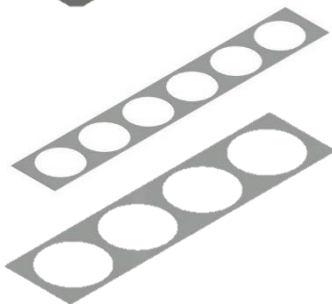

*Note: All wall and facade greening modules are available as custom-made product in any desired width up to 200 cm.*

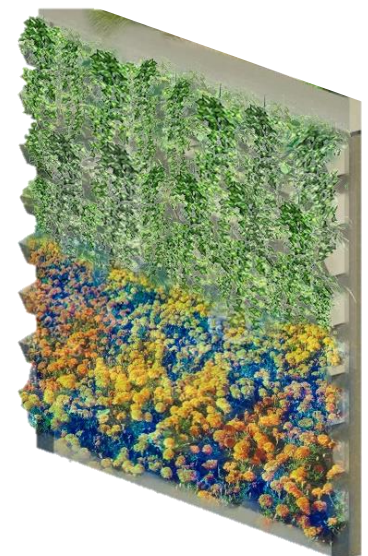

Modules arranged and planted as green wall.





# Hydro Profi Line® Greening Modules for Outdoors and Indoors



## HPL® Wall Greening Modules w/o overflow

## HPL® Special Cultiv. Pot

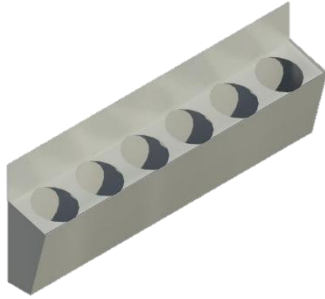

*in cm*

Module size: width 100 - depth 17,5  
 Rear cover height: variable, from 36 cm to 75 cm  
 Cultivation pots: 6 pc. x 1,3 liters  
 Material: stainless steel

EAN code: 4260369982737



size: 1,3 liters

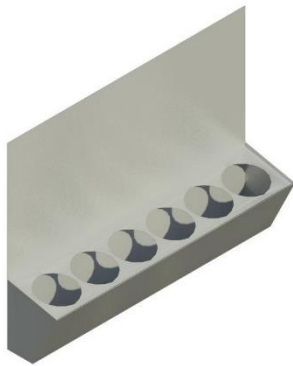

*in cm*

Module size: width 100 - depth 21,0  
 Rear cover height: variable, from 36 cm to 75 cm  
 Cultivation pots: 6 pc. x 2,0 liters  
 Material: stainless steel

EAN code: 4260369950637

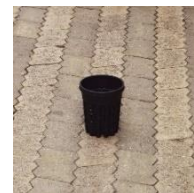

size: 2,0 liters



*in cm*

Module size: width 100 - depth 31,5  
 Rear cover height: variable, from 45 cm to 100 cm  
 Cultivation pots: 4 pc. x 3,0 liters  
 Material: stainless steel

EAN code: 4260369985752

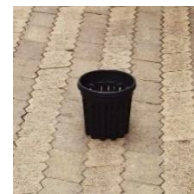

size: 3,0 liters

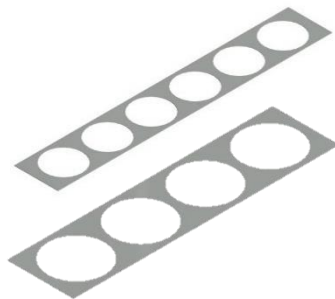

## Hydro Profi Line® System Plates

*Note: All wall and facade greening modules are available as custom-made product in any desired width up to 200 cm.*



Mounted modules





## Hydro Profi Line® Canopies for City Greenery

**The perfect solution for the intensive greening of the second level above existing public areas, transport and escape routes and other occupied areas.**



- The worldwide unique HPL® Canopies for City Greenery make an intensive greening possible on the level above existing and occupied city areas, which would not have been possible before.
- No additional space is consumed through the greenery and the existing city infrastructure remains untouched.
- Each canopy is equipped with the Hydro Profi Line® Planter System which enables a water supply solely with rainwater – robust and self-sufficient.
- The conventionally required irrigation effort and the corresponding freshwater consumption are eliminated.
- Through the integrated Quick Change System, all greenery desires can be installed, rearranged or exchanged at any time and without planting work.
- A quick and easy set-up, disassembly and relocation of the canopies to another site guarantee the flexibility required in the urban environment.
- The canopies are available made of wood or steel – in line with the requirements and to match the cityscape.
- Through the modular system, all canopies can be merged as desired – no limitations for areal planning.
- Permanently installed, the canopies can be used for various purposes throughout the year and the cities can rent them to the respective user.
- While bringing nature back into our cities, the canopies provide manifold application possibilities: as newspaper kiosk, event area, roofed outdoor sitting area or as a replacement for sun blinds in front of restaurants, cafés, and market squares.
- Besides the pure elegance of the canopy, the HPL® Systems offer the chance to bring green and all its benefits into our cities and onto our impervious surfaces. Depending on the local climatic conditions, all plant species in almost any size can be utilized.
- Moreover, the water consumption of the greenery is sustainably reduced by up to 80% compared to greenery without HPL® Planter Systems.

**Urban greening counters the Heat Island Effect, purifies the air, absorbs fine dust and this way caters for fresh air to breathe. Moreover, we provide habitats for bees, butterflies, birds and many other endangered species.**

**Let's massively green our cities to ensure resilience towards unknown climatic developments. This way we create sustainable high-quality urban environments, for us and our descendants.**



## Hydro Profi Line® Canopies for City Greenery



Enabling intensive urban greening – convenient & cost-effective.

**HPL® Canopies for City Greenery made of metal:**  
modular design, expandable and combinable as desired

- Set-up dimensions: 460 cm x 410 cm
- Roof ridge: height variable from 220 cm to 400 cm
- Roof greenery with HPL® Planter Modules consisting of:
  - 16 x Greenery modules for intensive/extensive greenery
  - 4 x Footway- / supply Modules

With their unique modularity, the HPL® Canopies can be installed and expanded at any desired site quickly and easily. Disassembly is possible at any time and relocation to a new site unproblematic. Depending on the local requirements, the ceiling, as well as the lateral faces, can be fitted with suitable coverings. The greenery on the roof area comes along with all advantages of the HPL® Planter Systems. The vertical lateral faces provide additional opportunities for a greenery with HPL® Wall and Facade Greenery Modules. Rainwater is utilized for the irrigation and sufficient. For Cities and municipalities within the EU, we offer a leasing scheme.



HPL® Canopies for City Greenery can be manufactured in any other desired size, shape and combination fitting to the respective cityscape and use case.

Additionally, further functions can be integrated into the HPL® Canopies like surveillance cameras, lighting, charging stations for e-bikes or mobile phones, flat screens for information and advertising purposes, radiant heaters, sales counters, Wi-Fi amplifiers, rainwater collecting tanks for excess rainwater etc.

... almost no limits for combination, expansion, and modification. Bringing GREEN into our cities.



## Hydro Profi Line® Canopies for City Greenery



### Enabling intensive urban greening – convenient & cost-effective.

HPL® Canopies for City Greenery are the perfect solution for the urban greening of cities and municipalities in countries with low rainfall: The integrated HPL® Planter Systems reduce the water requirements of the greening by up to 80% compared to conventional plantings.



The HPL® Canopies offer manifold possibilities to combine daily routine requirements with intensive greenery in our cities, from sales counters to a presentation space or for all-year-long public get-together urban spaces. This way we can massively green our cities and make them more resilient towards climatic changes, reduce air pollutants and fine dust and create healthy air for everyone.



The design of the canopies can be adjusted according to the required shape and size.

... almost no limits for combination, expansion, and modification. Bringing GREEN into our cities.



## Hydro Profi Line® Canopies for City Greenery



### Enabling intensive urban greening – convenient & cost-effective.

“As a Munich resident, a Munich entrepreneur and innovator of the first of its kind HPL® Planter Systems and the HPL® Canopies for City Greenery it was a deep desire to present these canopies to provincial capital Munich at first. I have chosen our beloved “Viktualienmarkt” as a vision for the greenery of impervious surfaces to showcase we can bring green into our city centers without touching the existing infrastructure and building areas. Certainly, the HPL® Canopies for City Greenery can be set up in any other city or municipality, respectively on any impervious surface to create sustainable intensively greened spaces without consuming any additional space and water.”

Wolfgang M. Plattner  
(Managing Director GKR-Germany)

**Vision: HPL® Canopies for City Greenery utilized for the subsequent intensive greening of the *Viktualienmarkt* in Munich. The canopies serve as replacement of or structure above the existing sun blinds.**

**Step 1: The image shows the magnitude of impervious surfaces at the “Viktualienmarkt” and the all-year utilization of sun blinds and sunshades in front of the respective market booths.**



... almost no limits for combination, expansion, and modification. Bringing GREEN into our cities.





## Hydro Profi Line® Canopies for City Greenery



Enabling intensive urban greening – convenient & cost-effective.

Step 2: This image shows the determination of areas for potential greenery by replacement of or as structure above the existing sun blinds and sunshades (marked in green in the image).



Step 3: The image displays the grid of the possible HPL® Greening Modules.



... almost no limits for combination, expansion, and modification. Bringing GREEN into our cities.



## Hydro Profi Line® Canopies for City Greenery



**Enabling intensive urban greening – convenient & cost-effective.**

**The Vision: The Munich Viktualienmarkt covered in a lush green with the HPL® Canopies for City Greenery.**

**Step 4: The image shows the diverse possibilities of greenery styles: Blossoming seasonal plants, evergreen woody plants, perennial plants, weeds, shrubs etc. Now, everything is possible without any irrigation work and at lowest maintenance effort.**



**Let's bring nature together with its beautiful diversity back into our cities. This way we establish wonderful urban environments for our insects like bees, butterflies and our birds – and for ourselves and our children. Now it is possible - convenient and cost-effective.**



## Hydro Profi Line® Canopies for City Greenery



Enabling intensive urban greening – convenient & cost-effective.

Possible Ideas for design and utilization: Greened octagon-shaped canopies e.g. for art display.



Let's start to massively green the impervious surfaces in our cities. Let's spread the message and implement green inner urban areas. Water and plants are our basis of life.  
**Let's join forces for a blue and green planet.**



... almost no limits for combination, expansion, and modification. Bringing GREEN into our cities.



## Hydro Profi Line® Canopies for City Greenery



Enabling intensive urban greening – convenient & cost-effective.

**HPL® Canopies for City Greenery made of wood:**  
modular design, expandable and combinable as desired

- **Set-up dimensions: 460 cm x 410 cm**
- **Roof ridge: height variable from 220 cm to 400 cm**

We manufacture HPL® Canopies for City Greenery made of wood according to the requirements of size, shape and wood species. After the canopy is designed, the fitting HPL® Planter Systems for the desired horizontal or vertical greenery are selected. Quick and easy installation and disassembly. Expandable at any time and independent of plant growth dismountable. Roof and wall covering as desired. Fitting all demands.

**HPL® Standard City Canopies made of wood** are not by default available, as regulations for application in different cities and countries vary too strong. With administrative approval, we are delighted to design and manufacture the required wooden canopies with integrated HPL® Greenery Systems as desired.



... almost no limits for combination, expansion, and modification. Bringing GREEN into our cities.



## Hydro Profi Line® Canopies for City Greenery



Enabling intensive urban greening – convenient & cost-effective.

**HPL® Canopies for City Greenery made of wood:**



Design of wooden canopies by architect and city planner  
Dipl. Ing. Horst Mallmann.

... almost no limits for combination, expansion, and modification. Bringing GREEN into our cities.



## Hydro Profi Line® Tall Plants System



Enabling intensive urban greening – convenient & cost-effective.

**For trees in pedestrian zones as well as on any other impervious surface.**

Trees in HPL® Tall Plants Systems require up to 80% less water compared to greenery in conventional planter systems and significantly reduce weight and required volume. The irrigation and maintenance effort is cut proportionally to the reduced water consumption. Moreover, even after years all trees can be exchanged and replaced easily and without planting work. The HPL® Tall Plants Systems can be produced in any other size and material as required.

**Dimensions round HPL® Standard Planter for Tall Plants:**

- Diameter: 124 cm
- Height 94 cm
- Fitting HPL® Special Cultivation Pot: 375 liters

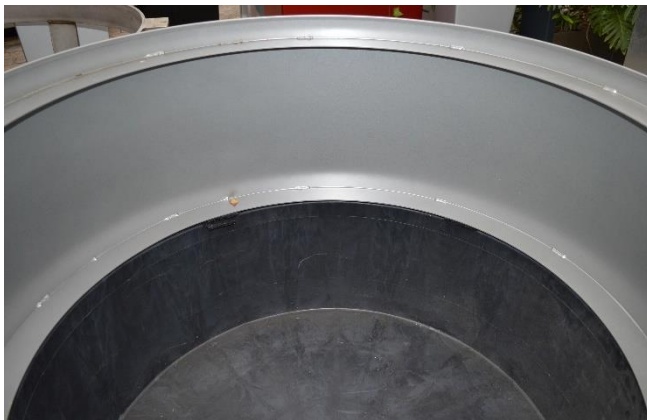

Water basin with overlying vegetation coat.

**Perfectly suited for all greening concepts with solitary plants or tall trees.**



HPL® Tall Plants System partly deployed without feet covering and HPL® Vegetation Zone Disc.



HPL® Tall Plant System equipped with a tree.



## Hydro Profi Line® Tall Plants System



Enabling intensive urban greening – convenient & cost-effective.

**For trees in pedestrian zones as well as on any other impervious surface.**

The images display the modular round HPL® Tall Plants System with its separate parts. Due to the modular system trees can be deployed quickly and easily on any impervious surface. A relocation to a new site is just as simple.

1. Position heavy-duty floor panel at intended site and equalize with height-adjustable feet
2. Put HPL® Water basin into floor panel fixation
3. Mount HPL® Vegetation Coat on water trough
4. Deploy plant inside HPL® Heavy-Duty Cage inside the vegetation coat
5. Put HPL® System Plate onto the coat and insert HPL® Water Level Indicator
6. Cover planter surface with the desired cover material (e.g. gravel) → That's it!



Heavy-duty floor panel with height-adjustable feet for leveling uneven surfaces.



Heavy-duty floor panel with HPL® Water Trough.

The HPL® Vegetation Coats are made of premium stainless steel and can be ordered brushed or powder-coated in the desired RAL-color.



Vegetation coat on water trough.



HPL® Heavy-Duty Cage holding HPL® Special Cultivation Pot.

**Now, even tall plants and trees can be set up quickly and easily on any impervious surface – including all advantages of the HPL® Planter Systems.**



# Hydro Profi Line® Tall Plants System



Enabling intensive urban greening – convenient & cost-effective.

**For trees in pedestrian zones as well as on any other impervious surface.**

Dimensions round HPL® Standard Container for Tall Plants:

- Diameter: 124 cm
- Height: 94 cm
- Fitting HPL® Special Cultivation Pot: 375 liters

## Separate parts of HPL® Tall Plants System round



HPL® Heavy-Duty Floor Panel (with height-adjustable feet)

Material: galvanized steel  
Size: diameter 124 cm

EAN code: 4260369985783

---



HPL® Water Basin

Material: Plastic with overflow hole

EAN code: 4260369985790

---



HPL® Vegetation Coat incl. Top Cover Panel

Material: stainless steel

EAN code: 4260369985806

*Alternatively*

Material: Steel powder-coated  
EAN code: 4260369985813

---



HPL® Heavy-Duty Cage (fitting HPL® Special Cultivation Pot 375 liters)

Material cage: corpus: galvanized steel, feet: stainless steel  
Material cultiv. pot: plastic

EAN code: 4260369985820

---

HPL® Floor Cover Ring (inside vegetation coat) (without illustration)

Material: stainless steel  
EAN code: 4260369985837

*Alternatively*

Material: Steel powder-coated  
EAN code: 4260369985844

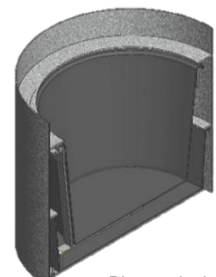

Planter design (cross section illustration)

**Now, even tall plants and trees can be set up quickly and easily on any impervious surface – including all advantages of the HPL® Planter Systems.**





## Hydro Profi Line® Tall Plants System



Enabling intensive urban greening – convenient & cost-effective.

**For trees in pedestrian zones as well as on any other impervious surface.**

Dimensions of HPL® KUBUS Standard Planter for Tall Plants:

- Width: 165 cm
- Length: 165 cm
- Height: 88 cm
- Fitting HPL® Special Cultivation Pot: 375 liters

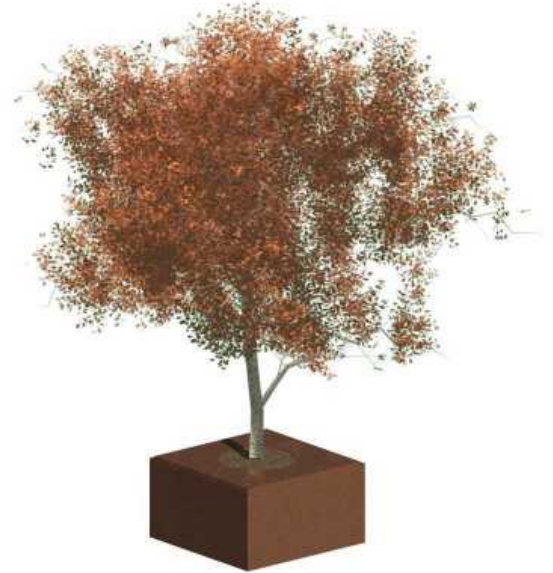

Coated HPL® KUBUS Planter for Tall Plants.



HPL® KUBUS Planter for Tall Plants with surrounding wooden park bench.



Powder-coated HPL® KUBUS Planter for Tall Plants.

HPL® KUBUS standard planters can be fitted to the individual demands: in any RAL-color, with a coating or add-ons like park benches, e-bike charging stations, spotlights etc. Let your ideas float and together, we will make them a reality.

Now, even tall plants and trees can be set up quickly and easily on any impervious surface – including all advantages of the HPL® Planter Systems.



# Hydro Profi Line® Tall Plants System



Enabling intensive urban greening – convenient & cost-effective.

**For trees in pedestrian zones as well as on any other impervious surface.**

The images display the modular rectangular HPL® Tall Plants System with its separate parts. Due to the modular system trees can be deployed quickly and easily on any impervious surface. A relocation to a new site is just as simple.

1. Position heavy-duty floor panel at intended site and equalize with height-adjustable feet
2. Put rubber mat on heavy-duty floor panel and position HPL® Water Basin upon it
3. Position HPL® Vegetation Coat into the water basin and align it
4. Deploy plant inside HPL® Heavy-Duty Cage into the opening of the vegetation coat
5. Put HPL® System Plate onto the coat and insert HPL® Water Level Indicator
6. Cover planter surface with the desired cover material (e.g. gravel) → That's it!



Heavy-duty floor panel with height-adjustable feet for leveling uneven surfaces.



Heavy-duty floor panel with HPL® Rubber Mat.



Heavy-duty floor panel with HPL® Water Basin on a rubber mat.



Heavy-Duty cage with HPL® Cultiv. Pot

The HPL® Vegetation Coats are made of premium stainless steel and can be ordered brushed or powder-coated in the desired RAL-color.



HPL® Heavy-Duty Cage in water basin



Vegetation coat on water basin with inserted HPL® Heavy-Duty Cage.

**Now, even tall plants and trees can be set up quickly and easily on any impervious surface – including all advantages of the HPL® Planter Systems.**



# Hydro Profi Line® Tall Plants System



Enabling intensive urban greening – convenient & cost-effective.

**For trees in pedestrian zones as well as on any other impervious surface.**

## Dimensions of HPL® KUBUS Standard Planter for Tall Plants:

- Width: 165 cm
- Length: 165 cm
- Height: 88 cm
- Fitting HPL® Special Cultivation Pot: 375 liters

## Separate parts of HPL® Tall Plants System (KUBUS)



HPL® Heavy Duty Floor Panel (with height-adjustable feet)

Material: galvanized steel  
 Dimensions: 160 cm x 160 cm  
 EAN code: 4260369985851



HPL® Stainless steel Basin with Rubber Mat

Material: stainless steel  
 Dimensions: 165 cm x 165 cm x 18 cm  
 EAN code: 4260369985868



HPL® Vegetation Coat incl. Top Cover Panel

Material: stainless steel  
 EAN code: 4260369985875  
*Alternatively*  
 Material: Stahl power-coated  
 EAN code: 4260369985882



HPL® Heavy-Duty Cage (fitting HPL® Special Cultivation Pot 375 liters)

Material Cage: corpus: galvanized steel, feet: stainless steel  
 Material Cultiv. plastic  
 Pot: 4260369985820  
 EAN code:



**Optionally available:**  
 HPL® KUBUS Tall Plants Planter  
 with surrounding wooden park bench.

**Now, even tall plants and trees can be set up quickly and easily on any impervious surface – including all advantages of the HPL® Planter Systems.**



## Hydro Profi Line® Planters for City, Areal, Terrace and Balcony Greening



**HPL® Planters** with integrated **HPL® Planter Systems** are ideally suited for all outdoor greening. All plant species like conifers, broad-leaved trees, shrubs, Mediterranean plants, blooming seasonal plants or herbs can be put into the **HPL® Planter Systems**. Now all advantages of the patented **HPL® Planter Systems** are available. Water consumption for greening with **HPL® Planter Systems** is reduced by up to 80% compared to conventional greening systems. Consequently, the otherwise necessary irrigation work is reduced at a similar high level. Independent of the impressive reduction of water consumption, the feature of quick and easy planting without requiring additional soil is itself revolutionary.

It only takes four steps for a greened planter:

1. Position **HPL® Planter** at desired location
  2. Insert **HPL® Systemic Plate** inside the planter
  3. Include the **HPL® Water Level Indicator** in the hole of the systemic plate
  4. Put **HPL® Special Cultivation Pot** in the **Systemic Plate**
- That's it – the **HPL® Planter** is greened

Thanks to the integrated **HPL® Quick Change System** sick or dead plants can easily be replaced without labor-intensive planting work, even after years: Simply lift the plant together with the **HPL® Special Cultivation Pot** from the **Systemic Plate**, empty the **Special Cultivation Pot** and put in a new plant. Finally, put the **HPL® Special Cultivation Pot** back on the **HPL® Systemic Disc** and that's it. All **HPL® Planters** for outdoors are equipped with a water overflow outlet which ensures spare rainwater to run off. The **HPL® Water Level Indicator** will inform you reliably about the planter water level and indicate when your plants need additional irrigation in case the natural rainwater is insufficient. All risks of false watering of greening are eliminated with **HPL® Planter Systems**: Watering is possible at any time and how much you want. Overwatering is impossible. All **HPL® Planters** are made of high-quality frost-resistant stainless steel or plastics. The planters can be varnished or color-coated with any RAL-color. Planters made of plastics are available with a structured or smooth texture. All varnishing and coating is resistant to UV. Most **HPL® Planters** can additionally be equipped with hidden rollers. Generally, the planters can be ordered in various shapes and sizes made of stainless steel or any other desired metal as well as plastics. You find our **HPL® Standard Planters** blank as well as pre-planted under: [www.gkr-hydro.de](http://www.gkr-hydro.de)

On the following pages, we present exemplary products of our product range of **HPL® Standard Planters**. Of course, we produce **HPL® Planters** made of metal or plastics individually in any size and shape according to your desires and requirements. All **HPL® Planters** can be constructed with integrated multifunctionality (take a look at pages 76f / GREETFU – GREENING with TECHNOLOGY for the FUTURE).



# Hydro Profi Line® Planters for City, Areal, Terrace and Balcony Greening

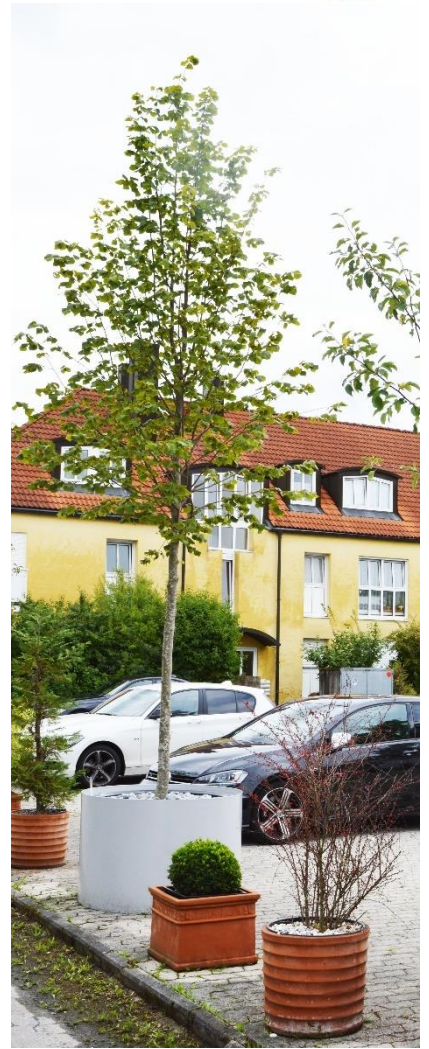

**HPL® Metal- and Stainless-Steel Planters** with color-coated surface



Mediterranean plants and broad-leaved tree in **HPL® Planters**



# Hydro Profi Line® Planters for City, Areal, Terrace and Balcony Greening



HPL® Planters made of stainless steel and HPL® Hanging Cubus.



We produce all HPL® Planters in any size and shape from stainless steel, metal or plastics.



## Hydro Profi Line® Planters for City, Areal, Terrace and Balcony Greening



**HPL® Planters** (made of plastic) are generally available in a wide variety of shapes and sizes.



**HPL® Balcony Troughs** (made of plastic) are also available with climbing plant support in each RAL color.



**HPL® Plastic Planter** with ivy hedge and **HPL® Room Divider** made of stainless steel or other metal as wanted.

Many other HPL® Standard Planters available pre-planted or blank under [www.gkr-hydro.de](http://www.gkr-hydro.de).



## Hydro Profi Line® Planters for Office, Indoor and Object Greening



**HPL® Planters** for office, indoor- and property greening can be equipped with all indoor plants in soil or hydroculture. Thanks to the integrated **HPL® Planter System** everyone is now enabled to supply any planting composition easily, without false watering and at any time. Otherwise necessary drying periods and the risk of watering too much become irrelevant. The **HPL® Water Level Indicator** provides the information about the water level in the planter and is reliable for many years. The planting compositions can be irrigated any time at whim. Furthermore, the water consumption is reduced by up to 80% compared to other greening systems. Consequently, the irrigation work is minimized and depending on the type of plant species and the location the planting compositions in **HPL® Planters** do not have to be watered for six or even seven months at all. **HPL® Planters** are available in a wide variety of shape, color and size, made of metal or plastics. The planters are waterproof and can be supplied with hidden roles if wanted. Without the overflow outlet, all **HPL® Planters** for outdoor greening can as well be applied indoors. Convince yourself under [www.gkr-hydro.de](http://www.gkr-hydro.de) and choose from our large assortment of **HPL® Planters** the planter matching your interior furnishings and desired greening. Do not forget the attractive renting models for property greening and be delighted from permanently appealing plants. Only healthy plants absorb fine dust as well as air pollutants and generate healthy air to breathe.



Optimal root formation of all plants in soil and hydroculture with the **HPL® Planter System**.





## Hydro Profi Line® Planters for Office, Indoor and Object Greening



The **HPL® Planters** are available with textured or smooth surface as well as with matt or gloss varnish.



We produce **HPL® Planters** in various shapes and sizes.

You find a large choice of **HPL® Planters** pre-planted or blank for purchase or rent as well as many other low-maintenance indoor greening products and decoration objects on our information and shopping website for businesses, municipalities, procurement managers and planners: [www.gkr-hydro.de](http://www.gkr-hydro.de)



## Hydro Profi Line® Room Divider for Office, Indoor and Object Greening



HPL® Room Divider with 2 levels



HPL® Room Divider and insight into the HPL® Quick Change System

**HPL® Room Dividers** impress with a modest design. We manufacture the **HPL® Troughs** of high-quality stainless steel and the side edges of steel in every desired RAL-color. Generally, the **HPL® Room Dividers** are available with two or three levels. The **HPL® Room Dividers** can be equipped with indoor plants in soil or hydroculture or with a combination of both. The integrated **HPL® Quick Change System** allows for a selective fitting of bloomers or herbs as well as a quick and easy replacement after withering or consumption. Imagine Christmas flowers during Christmas season or jonquils at Easter. For canteen or restaurant operation fresh herbs can be inserted regularly. **HPL® Room Dividers** come along with all advantages of the **HPL® Planter Systems**. Further benefits are outstanding noise insulation characteristics as well as the natural and healthy privacy shield feature.





## Hydro Profi Line® Plant Pictures for Office, Indoor and Object Greening (applicable as well outdoors)



**HPL® Plant Pictures** are perfect “living art” for every wall. Developed by W.M.-Plattner Design the pictures are entirely made of high-quality brushed stainless steel and hand-crafted by professionals. The pictures comprise of the **HPL® Planter System** and are 100 cm in widths, 80 cm in height and 12 cm in depth. They provide space for 40 plants in the cultivation pot size “round” 7 cm x 9 cm (the set contains the empty cultivation pots). Any plant in soil or hydroculture is applicable with the system. The pictures can be hung up as single image or widely extended to form a wall. The picture troughs are hand-watered and depending on location and size of plant’s do not have to be irrigated for up to two months. Two pre-drilled holes allow for an easy and quick installation on every carrying wall. Be it in the kitchen with herbs, in the office with orchids, palms and trailing plants or on the balcony with ferns combined with bloomers, all plant compositions unified in one picture constitute to one living masterpiece of art on every wall.





# Multifunctional HPL® Planters and Multifunctional HPL® Constructions for Greening of Impervious Surfaces Indoors and Outdoors



## Multifunctional HPL® Planters and Multifunctional HPL® Constructions:



Pedestrian zone greening with Multifunctional HPL® Planters

### LINEA FUTURA GREENING develops multifunctional Planters and Constructions with integrated HPL® Planter systems for greening of impervious surfaces.

In cooperation with qualified suppliers for the required additional features the Multifunctional HPL® Planters and HPL® Constructions are produced according to the demanded size, feature and design. HPL® Planters enable us to green impervious surfaces affordably, with minimum space requirements as well as maintenance work and sustainably. At the same time, we offer cities the unique opportunity to integrate the future supply requirements for technologies like e-mobility and other technical demands into this greening. This way, together we cater for a future with a better climate and greened and healthy urban open spaces.

We call this pioneering symbiosis:

### GREETFU – GREENING with TECHNOLOGY for the FUTURE

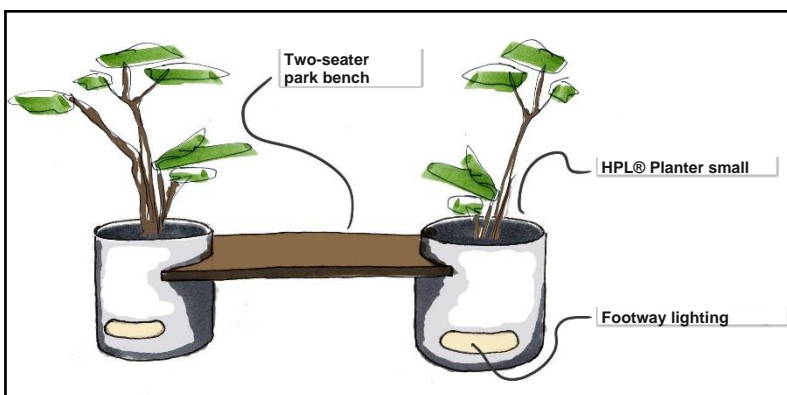

HPL® Planter with bench and integrated footway lighting

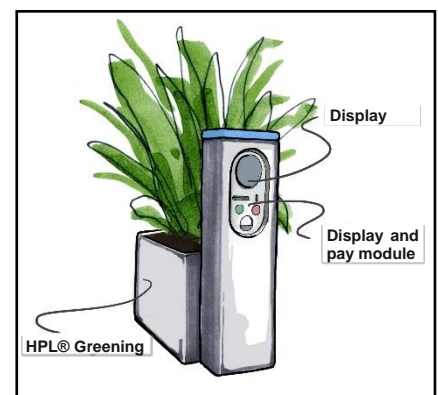

HPL® Planter with pay and display machine



# Multifunctional HPL® Planters and Multifunctional HPL® Constructions for Greening of Impervious Surfaces Indoors and Outdoors



## Multifunctional HPL® Planters and Multifunctional HPL® Constructions:



Sustainable parking lot greening with **Multifunctional HPL® Planters**, use case with integrated supercharger for e-cars and pay and display machine. Additional modules like surveillance cameras or parking lot lighting can be incorporated optionally.

### Demand analysis and solution approach

To green today's or future impervious surfaces with low space requirements, sustainably and efficiently, **Multifunctional HPL® Planters** and **Multifunctional HPL® Constructions** provide a perfect solution. All greening demands can be implemented quick and easy at every location. In cooperation with architects, city planners, municipalities as well as governments we analyze the local conditions and opportunities for greening in the respective urban areas and try to integrate additional technical demands like cameras, lighting or charging stations - efficient and with minimum space requirements. In association with the producers of the single technical components we develop solutions for the integration into our **Multifunctional HPL® Planters** and **Multifunctional HPL® Constructions**. Our utmost objective is to widely green impervious surfaces for climate improvement, reduction of air pollutants and creation of healthy urban open spaces for humans and animals.

### We design solutions to combine greening with technical products:

## GREETFU – GREENING with TECHNOLOGY for the FUTURE

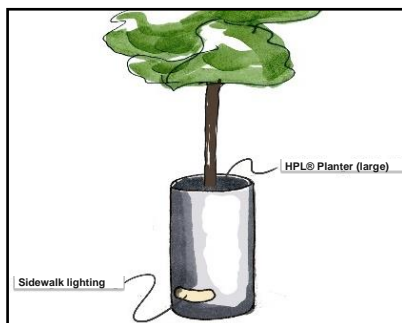

HPL® Planter with lighting for sidewalks and bicycle ways



HPL® Planter with charging station for e-cars including credit/debit card payment

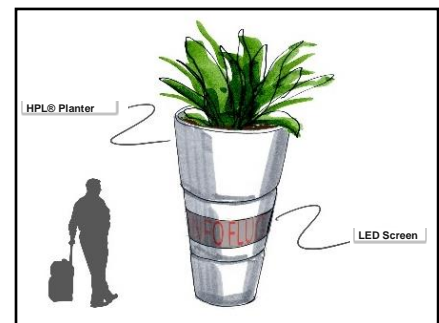

HPL® Planter as information column with LED screen



## Multifunctional HPL® Planters and Multifunctional HPL® Constructions for Greening of Impervious Surfaces Indoors and Outdoors



### Multifunctional HPL® Planters and Multifunctional HPL® Constructions:



**Vision of street lighting in Dubai:** Street and sidewalk lighting integrated into **Multifunctional HPL® Planters** combined with motion sensors and traffic guidance signposts.

#### Features and Design:

The features of the **Multifunctional HPL® Planters** are tailored to the demands and use cases. We develop the planter and construction design according to the area of operation and client demands. We produce mainly in Germany and with highest quality standards. All multifunctional planters and constructions contain **HPL® Planters** for sustainable conservation of our vital resource water.

**Likewise, streets can be illuminated energy-responsibly and greened sustainably with lowest maintenance work possible.**

### **GREETFU – GREENING with TECHNOLOGY for the FUTURE**



**Vision of street lighting in New York:** Additionally, cameras, speed control cameras or radio repeaters can be integrated into the **Multifunctional HPL® Planters**.



# Multifunctional HPL® Planters and Multifunctional HPL® Constructions for Greening of Impervious Surfaces Indoors and Outdoors



## Multifunctional HPL® Planters and Multifunctional HPL® Constructions:



Multifunctional HPL® Greening Staircase with attached information or advertising display; for indoors and outdoors.

Multifunctional HPL® Planters and Multifunctional HPL® Constructions can be integrated or fitted with any object. Attached elements like information and advertising displays are suitable to save space in public area greening. Other fields for application are display panels for vehicle speed at roadsides, current traffic situation on highways or event information at city limits.

Greened information and advertising messages at any location.

**GREETFU – GREENING with TECHNOLOGY for the FUTURE**

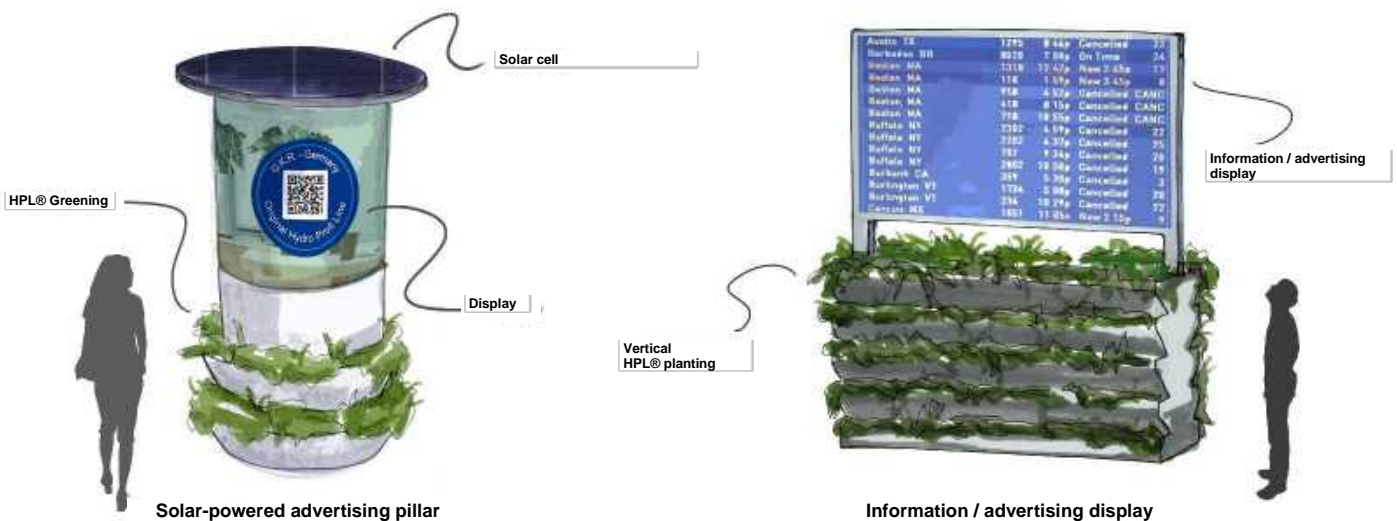

Advertising column with HPL® Base Greening and solar power system for power supply of the display

Multifunctional HPL® Greening Staircases can be produced in any size and shape according to the desired display size.



# Multifunctional HPL® Planters and Multifunctional HPL® Constructions for Greening of Impervious Surfaces Indoors and Outdoors



## Multifunctional HPL® Planters and Multifunctional HPL® Constructions:



Multifunctional HPL® Planter with e-mobility charging station upon lamppost

Available infrastructure like lamppost power connections can be used for supply of the equipment inside the **Multifunctional HPL® Planters**. At the same time, we transform dismal lampposts in greened city objects for healthy air to breathe.

## GREETFU – GREENING with TECHNOLOGY for the FUTURE

From visions to standard products like our **M&M Soundbox**:

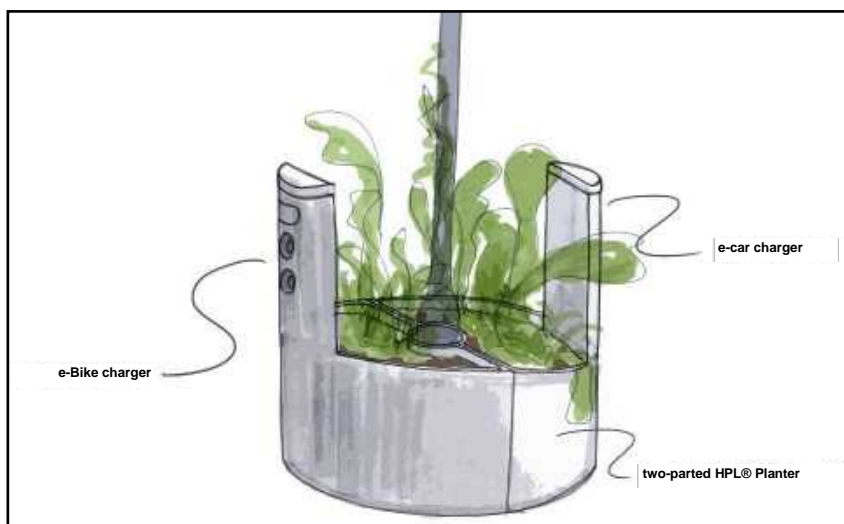

E-Bike and e-mobility charging station in Multifunctional HPL® Planter



Multifunctional HPL® Planter  
Product name: **M&M Soundbox**  
with integrated Sonos®3 speaker  
Information under: [www.gkr-hydro.de](http://www.gkr-hydro.de)





# Hydro Profi Line® Glossary

## Product Descriptions and Explanations



<b>Hydro Profi Line® (HPL®)</b>	Protected, registered product name
<b>HPL® Planter Systems</b>	Patented Planter System with unique root vegetation zone, with systemic disk or system construction in which plants are put floating over the bottom, with Quick Change System
<b>HPL® Special Cultivation Pot</b>	Special cultivation pot for all plants in soil or hydroculture; put in HPL® Systems
<b>HPL® Planter</b>	Planter with integrated HPL® Planter System
<b>HPL® Quick Change System</b>	Quick and easy exchange of plants in HPL® Planter Systems without planting work, selective and anytime possible
<b>HPL® Irrigation Wick</b>	Irrigation wick for inserting on bottom of special cultivation pot when utilizing poorly rooted plants or young plants, additionally prevents from withering of plants
<b>HPL® System for Building Greenery</b>	System for Building Greenery with water basins and utilization of rainwater for self-sufficient irrigation and a constant / temporary water circulation supply for HPL® Greening
<b>HPL® Irrigation System</b>	Mechanically or automatically controlled irrigation and drainage of individual water basins
<b>HPL® System for Building Greenery Outdoors</b>	System for Building Greenery with water basins integrated in a water circulation for facade modules, roof areas, balconies, terraces, yard areas for installation and subsequent supply of HPL® Modul Systems using rainwater
<b>HPL® Modules for Building Greenery</b>	HPL® Modules for areal greening, solitary plant greening, facade- and wall greening
<b>HPL® Modul System</b>	HPL® Modules can be installed horizontally or vertically, areally discretionary combined or bolted together
<b>HPL® Planter Module</b>	Plants in HPL® Special Cultivation Pots are put in HPL® Modules
<b>HPL® Areal Greening Modules</b>	HPL® Modules for areal greening consisting of a carrying frame and a planting basket
<b>HPL® Planting Basket</b>	HPL® Planting Basket for filling with planting substrate and subsequent planting of ground-cover plants, grasses etc.; for areal greening
<b>HPL® Carrying Frame</b>	HPL® Carrying Frame for holding HPL® Planting Baskets floating over the water
<b>HPL® Footway and Area Correction Modules</b>	Footway modules for installation between planter modules to access areal greening; correction modules to match planting area with water basin size
<b>HPL® Facade Greening Module</b>	Facade greening Modules for widespread greening of facades, walls and masonries
<b>HPL® System for Building Greenery Indoors</b>	Indoor greening system with water basins integrated in the water circulation for floorspace and wall greening modules using rainwater or freshwater supply
<b>HPL® Wall Greening Module</b>	Wall Greening Module for widespread greening of interior walls
<b>HPL® Stationary Module</b>	HPL® Stationary Modules for application of all plants in water basins with permanent location
<b>HPL® Mobile System</b>	HPL® Mobile System for application of all plants in water basins with variable location
<b>Multifunctional HPL® Planters and Constructions</b>	HPL® Multifunctional Planters and Constructions with integrated or built-on elements for additional technical value



# GKR-Germany I.E.P.T. Center

## Information, Exhibition, Planning and Training Center for Greening with Hydro Profi Line® Planter Systems



Covering more than 4.000 sqm, our new I.E.P.T. Center around HPL® Planter Systems presents all solutions for sustainable and long-term functioning greening of impervious surfaces and buildings, indoors as well as outdoors.

### Information- & Exhibition Center

#### Visit without consultation:

Monday to Saturday from 9.00 am to 4 pm

#### Individual personal consultation:

*with appointment*

#### Personal consultation & guided tour target audience 1:

Sales agents, specialist stores, landscape gardening companies, indoor landscaping companies, plant nurseries, gardening companies, garden centers, trade partners, facility managers, city and in-house nurseries

*with appointment*

#### Personal consultation & guided tour target audience 2:

Architects, landscape architects, project engineers, project developers, municipalities, property developers, home and commercial building companies, owners

*with appointment*

#### Guided tours for school classes and students

*with appointment*

### Planning Center:

In our **Planning Center**, our competent team of **HPL® Project Engineers** and **HPL® Product Developers** develop your greening ideas together with you:

- Our **HPL® Project Engineers** identify the HPL® System Components required for the execution of the available greening plan or required greening purpose. After order placement, they instruct our manufacturing plants and check the system components order-related before delivery.
- Our **HPL® Product Developers** and manufacturing plants plan and manufacture the required HPL® products according to the placed requirements

### Training Center:

Our **Training Center** conducts training for various interest groups with respective proof of qualification for use and handling of **HPL® Planter Systems**. The fee-based training are offered in German and English language. All qualified planning, manufacturing, trading and nursery enterprises are listed as **HPL® Qualified Company** according to the passed training and published on the **Hydro Profi Line® Homepage** as specialist respective to the individually offered services. The next training can be found under **[www.hydro-profi-line.com](http://www.hydro-profi-line.com)**

**I.E.P.T. Center: G.K.R.-Germany, Himmelschlüsselstr. 60, GER - 80995 Munich  
Telephone +49 (89) 15 91 480 / FAX +49 (89) 15 17 78**

More products like table planters, indoor and outdoor planters, pot-in-pot systems, plant pictures, office greenery solutions and many other available in our **Hydro Profi Line® System Catalogue:**



unique – sustainable – cost-saving – game-changing  
**Hydro Profi Line® Planter Systems**

for all horizontal & vertical greenery indoors and outdoors

Olive tree in Hydro Profi Line® Planter System



**HPL® Special Cultivation Pot  
for optimal root ventilation**

**HPL® System Plate**

**Unique root vegetation zone**

**Immense water reservoir**

The Hydro Profi Line® Planter System was presented as first of its kind with this olive tree during the 15. Biennale for Architecture in Venice



**Request for catalog and further information under [www.hydro-profi-line.com](http://www.hydro-profi-line.com)**



The first of its kind

## Hydro Profi Line® System for Building Greenery



For a lush greening of all rooftops, facades, terraces, balconies and other areas.  
All year-round self-sufficient supply of all greenery solely with rainwater and with  
add-on functionality for the supply of the indoor greenery.  
All benefits of the Hydro Profi Line® Planter Systems.

[www.hydro-profi-line.com](http://www.hydro-profi-line.com)



**Multifunctional Planters and Constructions with Hydro Profi Line® Planter Systems for space-saving, sustainable greenery with technological value-add.**

We call this symbiosis: **GREETFU** – GREENING with TECHNOLOGY for the FUTURE

Information under: [www.linea-futura-greening.com](http://www.linea-futura-greening.com)

